

**OPERATING INSTRUCTIONS  
AND  
MAINTENANCE MANUAL  
FOR**

**HAMMONDS MODEL 1600-1P7**

**FLUID POWERED  
ADDITIVE INJECTOR SYSTEM**

Manufactured by:



**HAMMONDS TECHNICAL SERVICES, INC.**

6807 W. Little York Rd.  
Houston, Texas 77040

Phone: 281-999-2900  
Fax: 281-847-1857

[www.hammondscos.com](http://www.hammondscos.com)

October 2016

# Hammonds Model 1600-1P7 Injection System Manual

## TABLE OF CONTENTS

Special Notice to Users	3
Installation and Preparation for Startup	3
Installation Considerations of Bare Units	4-5
Locating the System	5-8
Additive Supply System	8-10
Additive Tank Installation	11-13
Preparation for Calibration and Startup	13-14
Calibration and Startup	14-17
Additive Chart	17
Trouble Shooting the System	18
Preventive Maintenance	19
Preventive Maintenance Schedule	20
Desiccant Dryer Instructions	20-21

### Attachments:

Drawings and Parts List
System Layout
Hydraulic Schematic
Drive Unit
Gear Reducer
Injector Pump
Calibration Gauge
Calibration Gauge Instructions

# Hammonds Model 1600-1P7 Injection System Manual

## SPECIAL NOTICE TO USERS PLEASE READ CAREFULLY BEFORE OPERATING EQUIPMENT

This additive injector system is designed to give consistent dependable performance when operated and maintained according to manufacturer's recommendations. However, being a mechanical device, it is subject to failure from improper installation, wear, human error and operating environments beyond the control of the system. Because of this fact, it is the responsibility of the operator to make certain that:

- A. The system is installed properly.
- B. The system is being operated properly.
- C. The system is actually running during product transfer.
- D. The system is checked after the transfer operation to make certain the proper amount of additive was injected during the operation.

The performing of these checks by the operator eliminates the possibility of product not having the proper additive ratio as required. Therefore, since the manufacturer cannot be present during each transfer operation, the responsibility for checking the performance of the system is that of the operator. Should there be any questions whatsoever, the operator should consult the distributor from whom the unit was purchased.

**Do Not Take Chances.....Do Not Guess.....Be Absolutely Certain That The System Is Installed And Working As It Should.**

**The user/ operator carries the final responsibility to make certain the system is operating properly.**

## INSTALLATION AND PREPARATION FOR STARTUP

In most cases, the Hammonds fluid powered injector is shipped complete and ready to operate. The system should include appropriate fittings to suit your specific application. Flow direction is marked on additive pumps and check valves. Any and all flow restricting devices such as on/off ball valves, remote panels, sight flow indicators, suction strainers or electrically controlled solenoid valves must be installed on the suction side of additive pumps.

### **CAUTION**

**Do Not Attempt To Use This Device Without Understanding And Following Proper Safety Precautions Regarding System Grounding, Fire Safety, And Special Handling For Potentially Dangerous Additives.**

Consult your Engineering Department for their specific instructions. Make certain all personnel involved with this system are thoroughly familiar with safe operating practices.

If your system has been purchased "bare," consult your equipment distributor for help in selecting hoses, fittings and other related accessories. Selection of materials compatibility, location of unit within the system, effect of the unit on the system and injection point of the additive are also factors that should be discussed by factory authorized personnel.

If no factory authorized distributor is available, consult the factory directly for assistance.

# Hammonds Model 1600-1P7 Injection System Manual

## INSTALLATION CONSIDERATIONS OF BARE UNITS

Hammonds additive injector systems may be installed in a wide variety of applications, systems, and operating conditions. **This Manual Makes The Assumption That The Purchaser Has Consulted With A Factory Authorized Distributor Or The Factory And Has Approval For The Application And Installation.** If this is not the case, listed below are a few considerations that should be reviewed before installing a unit in an existing system.

### POINT OF INJECTION OF ADDITIVE

Some additives may adversely affect other components in the product handling systems, for example seals in meters, valve seals, aluminum and filter elements to name a few. The Hammonds injector systems do an excellent job of mixing the additive in the product, and does not inject in large slugs. Because of this superior mixing and very small concentration of additive in any one point, many customers feel that this is not a problem. **SOME DO**, and therefore, should use their own judgment as to the effect of these additives. **Hammonds Technical Services, Inc. Can Only Advise You Of The Possible Hazards.** It is up to the owner to decide his preference as to location of the additive injection point. It can be placed at any point in the system. The 1600 comes with the injection point directly ahead of the fluid motor for good blending. It can be located elsewhere very easily. If the injection point is moved from the body of the injector, the 3/4" NPT threaded hole must be plugged, the inlet check valve moved to the new location, and the injection tubing rerouted to the new location. An injection check valve must always be used regardless of location.

### WHERE TO PHYSICALLY MOUNT THE INJECTOR

The Model 1600 can be mounted in most any convenient location. Standard product connections are 150# RF 10" inch flanges. The performance of the 1600 is not affected by changes in pipe direction or other components such as valves, strainers or meters directly before or after the injector. However, care should be taken in placing the unit too close to other items such as turbine meters that may be sensitive. Consult other manufacturers for advice in placing the injector adjacent to their specific equipment.

### MOUNTING ATTITUDE

The Hammonds injector can be mounted in a horizontal, vertical, or even a slanted pipe with one condition. The main motor shaft that powers the injector **MUST always** be horizontal. If this is not done, premature wear will occur in the unit, causing flow tolerances in the unit to become excessive. This will lead to a loss in the system's ability to operate correctly at low flow rates. **Study The Installation Drawing At The End Of The Manual Carefully. Consult Your Local Distributor Or The Factory If You Have Any Questions Whatsoever.**

### INSTALLATION RELATIVE TO METERS

Hammonds injectors can be installed at any point in the system. If the unit is mounted downstream of the meter, the injection point may be moved upstream of the meter in order to measure the amount of additive being measured.

# Hammonds Model 1600-1P7 Injection System Manual

## SPACE REQUIREMENTS

The system is designed with easy service in mind. The entire rotor and pump assembly can be removed, where possible, from the housing without disturbing the system piping. Ample room should be reserved in the installation for this removal. The injector pump is removed from the side in which it is mounted. Should the fluid motor need service, it is typically done from the backside. A clearance of 24" is required on the backside to remove the rotor and rear side plate. An equal amount is necessary to remove the rotor and shaft from the front or injector side. Also, allow room for the operator to have visual access to the controls on the pump for calibration purposes.

## ON/OFF OPERATION

Two methods may be used to stop or start injection. For standard diaphragm pumps a valve may be installed in the suction side of the system that acts to interrupt the flow of additive to the injector. This may be either a manual valve or solenoid operated. For best results, the valve should be located as close to the injector as possible. **Caution:** If a solenoid operated valve is used, make certain the orifice size is large enough to cause no restriction in flow of the additive. In addition, the valve **Must Be Direct Acting**. Many valves are "pilot operated," meaning that they require at least 5 PSI line pressure in the line. **This Type Of Valve Will Not Work In This Application.**

Remember, the suction side of the injector may be either at a very low pressure or a slight vacuum. Therefore, a direct acting valve must be used. Make certain valve trim elastomers are compatible with the additive. Even slight swelling of the valve seals can cause erratic operation and, in some cases, total failure of the valve.

Here is how it works. Since the injector is a diaphragm type pump, it can be operated without fluid damage. When the additive supply valve is turned off, the injector simply maintains a suction on the additive line until the valve is opened for operation. The injector immediately begins pumping when the valve is returned to the ON position. Most injector pumps used on the Model 1600 can operate in the OFF position with the suction blocked. However, there are some special units (rotary pumps) that cannot be blocked. These will be labeled accordingly. If there are any doubts, please consult the factory.

The second method for ON/OFF operation is to provide a 3-way valve on the discharge side of the injector. One position sends output to the product line, the other sends output back to the tank. Make certain the valve used does not have a blocked center position as blocking the discharge of the injector will cause serious damage. This is the only recommended method for Rotary Pumps.

## LOCATING THE SYSTEM

In rack loading installations, there are usually several locations for installing the system.

The first choice would be remote from the island at some point in the main product line between the product pump and where the pipe goes underground or overhead, leading to the

island itself. This type installation is usually used in cases where all the product handled by the island will be treated. Although the additive can be turned off, if two loading arms on the island are being used simultaneously, it is not possible to isolate one and not the other for injection.

# Hammonds Model 1600-1P7 Injection System Manual

## INJECTOR LOCATION FOR OFF-ISLAND INSTALLATION

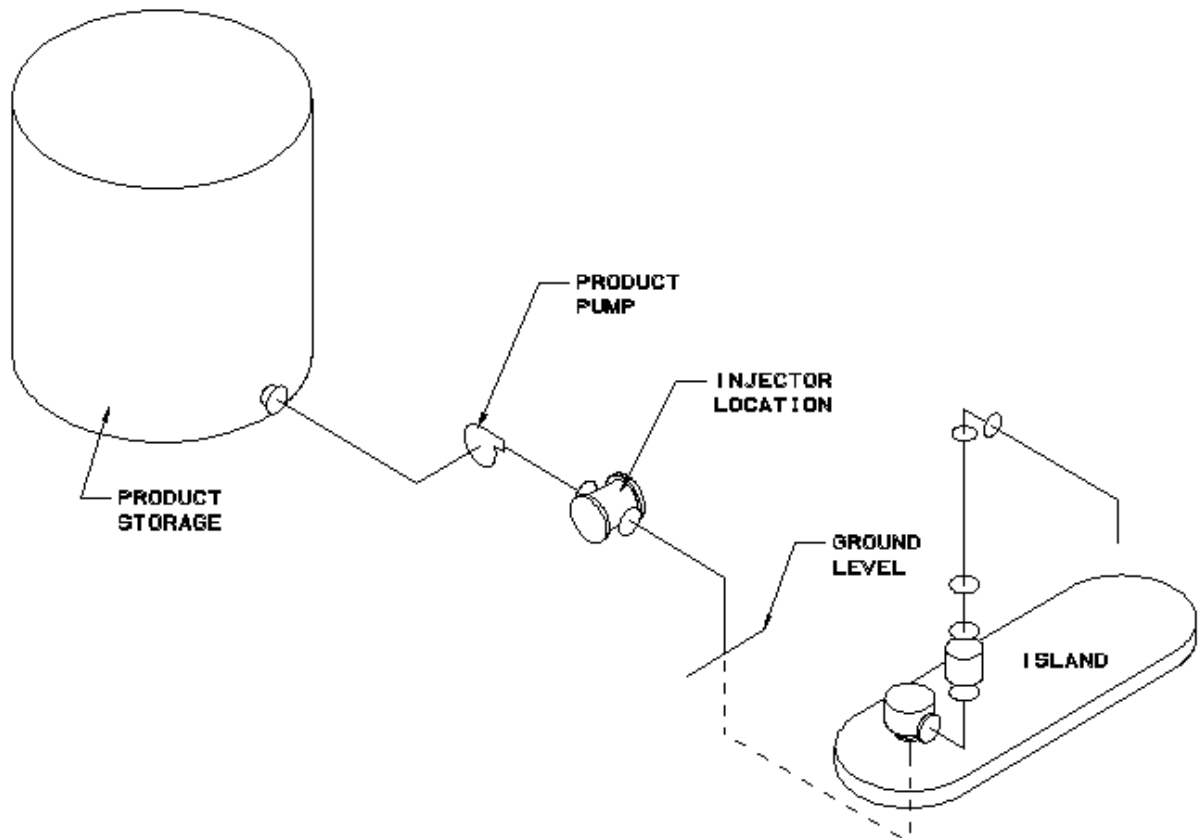

The injector should not be located between the product pump and the product storage tank.

In remote island installations such as illustrated above, positive displacement drivers can be used in either horizontal or vertical straight runs of pipe.

The other option for basic location is on the island itself. In this installation, a unit is usually placed on each of the loading arms,

providing for the selective injection of any combination. The unit may be installed at any point from where the pipe exits the ground to where the swivel arm begins for the hose drop. This location offers versatility in that a single injector can be shared by up to four (4) separate users, injecting different additives on demand. There is almost always a convenient "spot" to install the system in a short run of straight-line pipe.

# Hammonds Model 1600-1P7 Injection System Manual

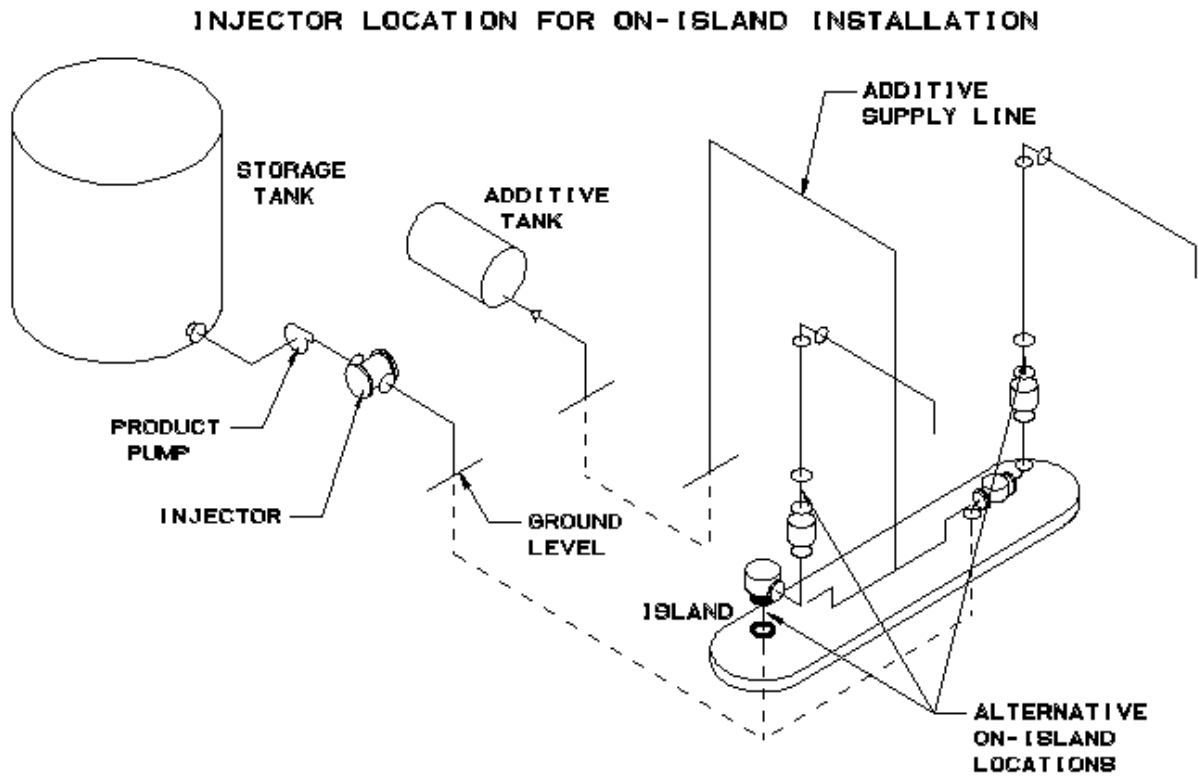

Location of the injector at the island is usually handy to existing wiring conduits for card controls, allowing for easy installation of the on/off solenoid. Units can be configured for horizontal or vertical installation.

## ***CHOOSING THE SPOT FOR INSTALLATION OF THE UNIT ON THE ISLAND***

Most island loading arms will present at least two and sometimes three mounting options. Consideration should be given to serviceability and traffic of personnel and equipment such as swinging hoses.

# Hammonds Model 1600-1P7 Injection System Manual

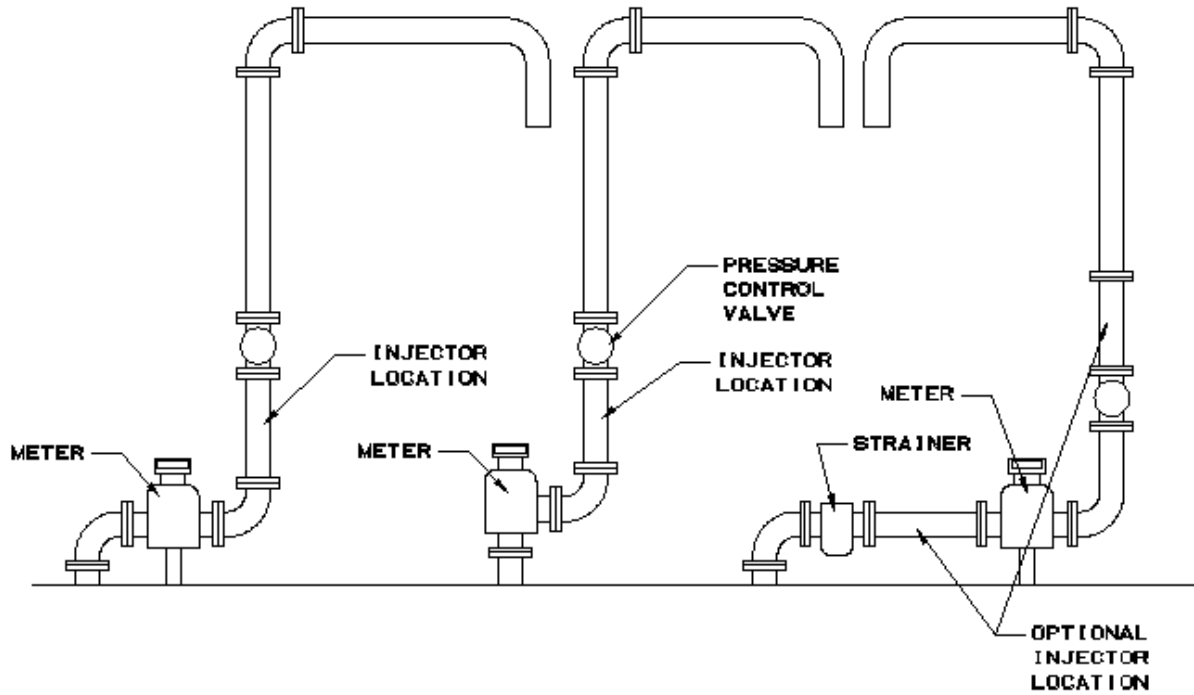

## ADDITIVE SUPPLY SYSTEM

The additive tank should always be placed as close to the injector as possible. Ideally, the tank should be at the same level or slightly higher than the unit providing a flooded suction to the injector. If this is not possible, the injector, depending upon the application and the model of pump, will pull a suction lift. **NOT ALL PUMPS WILL.** The end user is responsible to make sure there are absolutely no leaks in the suction line of the injector. A pin hole will prevent the system from priming

and/or operating efficiently. Tape all connections carefully with Teflon® sealant. Consult your engineering department or the factory for assistance with any application concerns.

The following illustration identifies the basic components necessary for a complete additive supply system. Study the information provided for each component, as each part plays a vital role in the overall performance of the system.

# Hammonds Model 1600-1P7 Injection System Manual

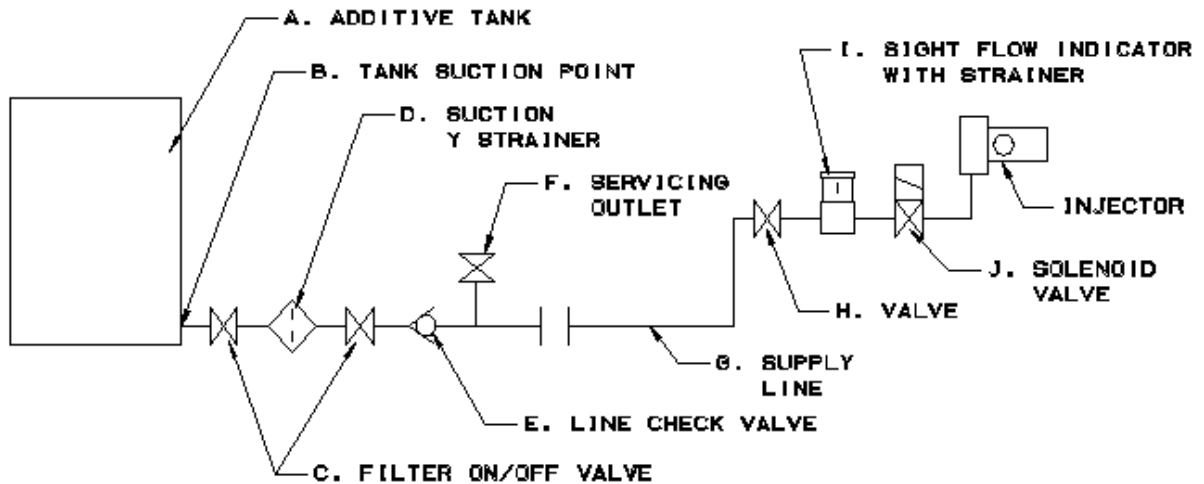

**A. THE ADDITIVE TANK:** Additive tanks should be constructed of materials compatible with the additive. Tanks should be new and free from scale, rust and corrosion. Any loose surface material inside the tank will fall into suspension and contaminate the additive after startup. Care should be taken to prevent sandblast sand from entering the tank during the manufacturing process. If water is used for testing, the tank should be dried internally to prevent the formation of rust.

**B. TANK SUCTION POINT:** Suction should never be taken from the very bottom of the tank. Should foreign material of any kind be present, the line will become plugged, causing either failure or erratic performance of the system. Remember, there are components

in every additive system that are sensitive to contamination. Suction should be taken at least 1" off the bottom of the tank to prevent the introduction of foreign sediments off the bottom.

**C. FILTER ON/OFF VALVE:** A full opening ball valve of at least the diameter of the additive supply line should be placed on either side of the suction Y strainer. Two valves are necessary in order to clean the strainer without losing the entire line full of additive. This will prevent having to re-prime the system each time the strainer is cleaned.

**D. SUCTION Y STRAINER:** A large Y type strainer with a screen opening of not more than 50 is ideal for taking most harmful

# Hammonds Model 1600-1P7 Injection System Manual

particles from the additive supply. Any smaller mesh will cause excessive friction loss. If the openings are too large, the strainer will do little to protect the system.

**E. SUCTION LINE CHECK VALVE:**  
*Notice: This check valve is only used in vary rare occasions. Consult the factory before use.* This suction line check valve is used to provide additional insurance that the primed line will not drain back between uses. If the additive supply line is properly installed without leaks, it will remain full even when not in use. This line check valve is suggested as an extra precaution to prevent loss of system prime. The valve should be made of a material compatible with the additive, and have a “feather light” opening pressure. The valve should be a ball type with a synthetic material that is very light, preferably with no spring. The gravity of the material will seat the ball. Consult the factory if there is any question regarding the proper valve for this application.

**F. SERVICING OUTLET:** The service outlet provides a means for operating a manual pump in the additive supply line. The pump can be connected and used for purging air from the line while priming. Although this is an option, the factory strongly recommends the accessory for easy startup and service. A simple tee and on/off valve is used for this purpose.

**G. ADDITIVE SUPPLY LINE:** The size of the delivery line to the injector is important when long distances are involved. Use the following chart for determining line size.

0 - 500 PPM up to 25'	1/2"
25 to 50'	3/4"
50 to 100'	1"

Over 1000 PPM up to 25'	1-1/4"
25 to 50'	1-1/2"
50 to 100'	2"

The above line sizes are a suggestion only. Make certain to use at least 1 size larger than the inlet size of the pump you are supplying. Consult the factory for greater requirements.

**H. SIGHT FLOW/STRAINER VALVE:** This valve is also a full opening ball valve that is used to isolate the additive line when cleaning the strainer in the Sight Flow Indicator.

**I. SIGHT FLOW INDICATOR/SUCTION STRAINER:** This strainer is used to provide indication of the system’s operation, as well as add extra protection for the solenoid valve from trash and contamination. When properly installed, this indicator will give the operator proof that the system is operating properly.

**J. SOLENOID VALVE:** This valve is provided for the remote operation of the system. It is important that the valve is a direct acting type that requires no pressure from the line in which it controls. The materials of the valve body and the elastomers are extremely important as any reaction with the additive can cause failures. Consult the factory to make certain that the valve and trim materials are compatible. Also, make certain that the orifice in the valve is at least 7/16”, with 5/8” being ideal. Any restriction in this orifice will cause the system to work harder to perform the given ratio of injection.

# Hammonds Model 1600-1P7 Injection System Manual

## ADDITIVE TANK INSTALLATION

Placement of the additive tank and related supply lines relative to the injector is critical to performance of any additive system. The following illustrations will provide information regarding the various types of tank installations and their connection to the additive injectors. Hammonds injectors offer the greatest flexibility in tank and supply line installation of any additive injection system on the market. Since no pumps or feed

mechanisms are necessary, installation goes faster and at less cost. The choice of appropriate components and pipe sizes, along with leak-free installation, will determine if the system works properly and consistently.

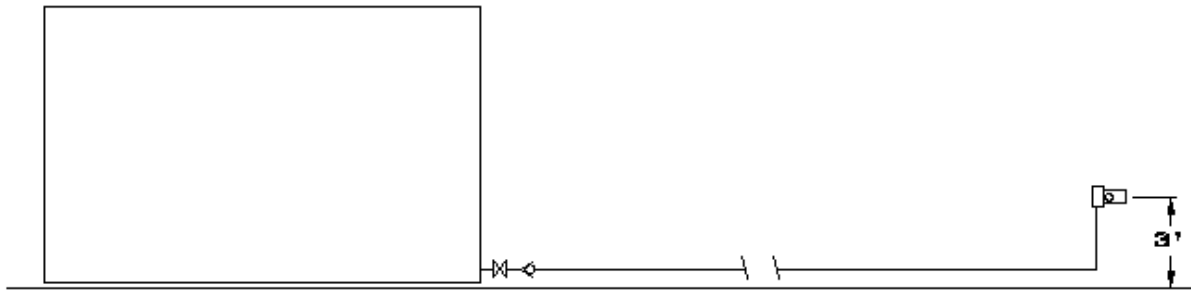

### ***OPTION 1 - ABOVE GROUND TANK, ABOVE GROUND DELIVERY LINES***

This installation calls for both the tank and the supply lines to be above ground. The bottom of the tank is very close to the ground, and the injector is approximately 3' above ground. Using a 4' diameter tank, this would provide a variable net suction head to the injector of +1' when the tank is full to a worst condition of a -3' when the tank is almost empty. A Y type strainer should be located at the tank. A full opening ball valve located on each side of the strainer, with a light action (less than 1/2 PSI) check valve installed to assist in holding the prime. Install a ball valve just upstream of the Sight Flow Indicator, and if one is to be used, install the solenoid-operated valve between the Sight Flow Indicator and the injector. Use the table listed in the previous section for selection of pipe diameter.

# Hammonds Model 1600-1P7 Injection System Manual

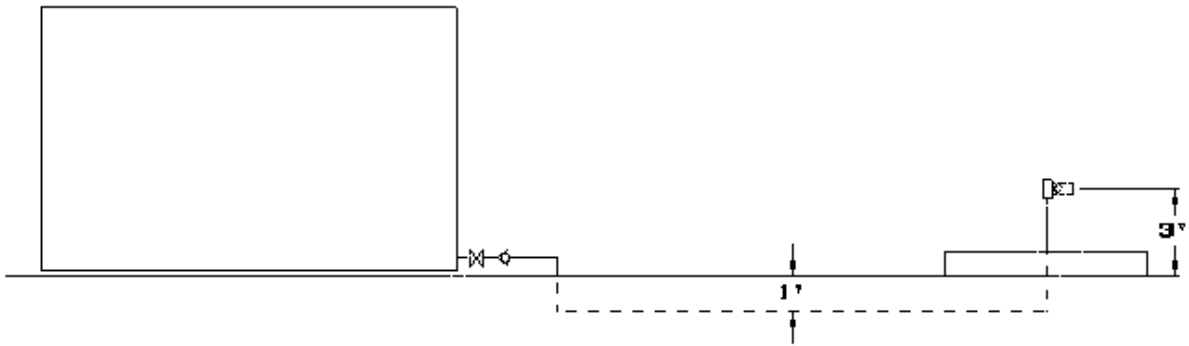

## ***OPTION 2 - ABOVE GROUND TANK, BELOW GROUND DELIVERY LINES***

This option is basically the same as that in Option 1. The effect of burying lines below the ground level does not affect final suction conditions since the head gained in going below ground level offsets the additional lift at the injector end. It is necessary to make certain on initial startup and priming of the system that all air is removed from the supply lines and the various components.

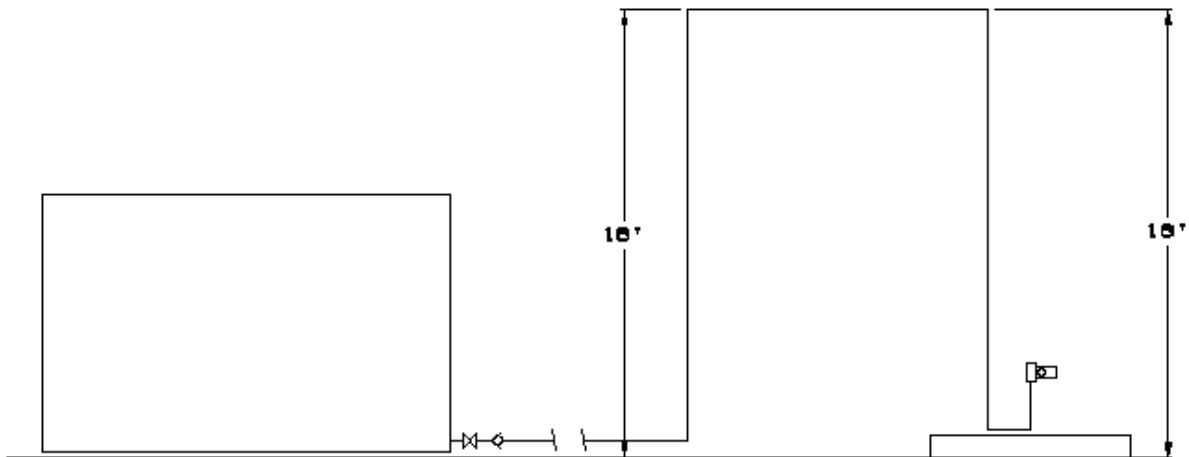

## ***OPTION 3 - ABOVE GROUND TANK WITH HIGH CLEARANCE OBSTACLE***

This application for a non-pressurized additive system is difficult to achieve in the real world because fittings and check valves notoriously leak. . This is not recommended. If equipment is installed in this manner it will void the factory warranty.

# Hammonds Model 1600-1P7 Injection System Manual



## ***OPTION 4 - BELOW GROUND TANK, BELOW GROUND LINES***

This is the most difficult application for a non-pressurized additive supply. In this case, the pump must overcome a negative lift equal to the total distance between the bottom of the tank and the injector above ground.

**This is not recommended because fittings and check valves leak. If equipment is installed in this manner it will void the factory warranty.**

## **PREPARATION FOR CALIBRATION AND STARTUP**

**Before Attempting To Start The System Or Make Calibrations, Please Read The Following Information Carefully.**

During startup and calibration, you will be bleeding the system of air, collecting samples of additive during the calibration and checking for possible leaks throughout the system. Provisions should be made for collection or clean-up of spilled fluid. Attempts should be made to minimize losses during these procedures. If the additive being handled is flammable, fire safety precautions should be taken. Since the installation may also be tested at this time, extreme caution should be used in checking for leaks of the main line. If you wish to set the system up for leak-free testing and calibration with zero spillage, please consult your local distributor or the factory for help in doing so. Hammonds is glad to suggest any

necessary parts and procedure for "zero spill" startup and calibration.

### **A WORD ABOUT ADDITIVES**

Most additives being used in fuels today have at least some degree of toxicity. Many are very dangerous. Extreme caution should be taken in handling additives. Remember, the additive is placed under pressure when being injected into the line, and when collecting samples during calibration, some spillage may occur. Be careful, wear protective clothing including eye protection. Be sure you have facilities to wash off any additive that may come in contact with your skin. Read all additive manufacturers safety precautions and Material Safety Data Sheets, following them to the letter.

# Hammonds Model 1600-1P7 Injection System Manual

HERE IS WHAT IS NEEDED:

Appropriate safety protection equipment.  
Eye protection in the form of safety goggles.  
An assortment of wrenches that fit the various fittings on the system. Note: two (2) 10" crescent wrenches will normally take care of any adjustments to fittings you may have to make. One to hold the fitting, and one to hold the adjacent fitting.  
A marked graduated glass bottle that is marked in either CC's or ounces. (At least 16 oz.)  
A stop watch.

A means of determining the flow rate of the main system.

A small pocket calculator is helpful.

A clipboard is helpful with pad of paper.

**AT LEAST ONE, AND PREFERABLY TWO HELPERS**

A large container or catch basin to collect the output of the pump while you are not actually calibrating the system.

**REMEMBER:** Any plumbing system varies with temperature and fluid being pumped. The system also changes as parts of the pump wear.

## CALIBRATION AND STARTUP

**IF YOUR INJECTOR SYSTEM IS EQUIPPED WITH CALIBRATION GAUGES, FOLLOW THE INSTRUCTIONS FOR THEIR USE IN THE BACK OF THIS MANUAL.**

### **PROPER ADDITIVE INJECTION RATIOS**

**Although volumetric calibration at atmospheric pressure will bring you within an acceptable range of additive injection, the only true evaluation for proper ratio is the ASTM D-5006 evaluation for fuel system ice inhibitor (FSII). Do not depend on volumetric calibration to ensure on-spec performance because line pressures can vary and additive injector parts wear over time. Contact Hammonds Fuel Additives, Inc. for supply of quality fuel system ice inhibitor and fuel testing procedures.**

**Please follow these steps in their given order. Read them over carefully before starting, and then follow them to the letter. If there is any part of the procedure that is not clear, consult your local distributor or the factory directly.**

1. Make certain the additive tank is full of the proper additive.

2. Open the suction valve between the tank and the pump. This valve should be located at any point between the additive tank and the injector.

3. All systems are calibrated at the factory to customer specified requirements. So if adjustments are required, they should only be minor. If this is the case, go directly to step 6.

**4. FOR HAMMONDS PUMPS ONLY:** If you are starting from scratch in the calibration and adjustment, loosen the stroke adjustment locking screws located on the bottom of the pump body directly under the stroke adjustment knob. This will allow the stroke adjustment to be moved. These are not the dial knobs within the circle of numbers, these are lock down screws.

# Hammonds Model 1600-1P7 Injection System Manual

## 5. **A. FOR HAMMONDS PUMPS ONLY:**

Adjust the stroke adjustment knobs located on the pump body to approximately 50%. **CAUTION:** Do not turn these adjustments with excessive force. If they are difficult to adjust, simply rotate the main rotor shaft, by producing flow in main product line. Lock the stroke adjustment locking screws down firmly.

## 6. **B. FOR SPECIAL ROTARY PUMPS:**

To increase injector output, turn hand crank to next number. To decrease output, turn to higher number. **CAUTION: Only adjust variable belt drive while fluid motor is turning.**

7. Set the calibration valve (3-way valve) in the "calibrate position." This is done by making certain that the handle on the valve is positioned so that additive will exit through the short open tube.

8. Make certain all product connections going to and from the system are in their proper, locked position to ensure safe, leak proof flow of product through the fluid motor. Double check the flow direction arrows located on the fluid motor housing, and check valves before and after the pump to ensure that the system is installed properly.

9. At this point, consider the information you will have to gather during the next few steps of the calibration process.

A. What will the flow rate through the unit be?

B. What is the length of time that the calibration will cover?

C. What is the amount of additive in ounces or cc's that you will need to collect based on the duration of the calibration.

**You Should Have the Answer To All Of These Questions Before Your First Trial Run.**

10. Before starting the main product flow through the system, make certain everyone understands that you will run the system for, let's say, one (1) minute. Even shorter runs are fine, especially if you are running at high flow rates.

11. Place the measured graduate under the calibration tube. Put on your eye protection.

12. At the command of the time keeper, or that person watching the flow meter, start the main product pumps.

13. Give the system a few seconds to gather momentum and flow through the fluid motor. Notice if the additive injector system is turning. The bearing on the shaft under the stroke adjustment knob cover should be spinning.

14. If the pump is being started up for the first time, it will take a few seconds to prime itself and begin discharging fluid from the calibration tube. Is your eye protection on? If not, **PUT IT ON NOW!**

15. As soon as the pump begins discharging a clear, air free stream of fluid from the calibration tube, you are ready to begin your calibration. At this point, the system is primed. **\* Hammonds recommends using the Pressure Simulating Calibration Devise, an optional accessory item, to duplicate system pressure during calibration.**

16. You will now prepare to make your first actual calibration run. Empty your collected additive back into the tank, putting the bottle back under the calibration tube. Notice the setting on the main product meter, set your stop watch at zero.

17. When ready, start the system again. Stop it at the decided time interval or meter reading. Calculate the amount of product that

## Hammonds Model 1600-1P7 Injection System Manual

traveled through the system. Measure the amount of additive gathered, and record the amount of elapsed time.

18. It will be at this time that you will have to calculate how much additive you should have collected for the amount of fuel that the system pumped. This, of course, depends upon the ratio that is required. The following example is the easiest way of explaining the procedure without getting too complicated. It is not the only way...use it if you like.

Example condition: Amount of product pumped: 500 gallons

Ratio of additive desired: 250 PPM (Parts per million)

It is assumed that the operator will know how much product is being pumped through the system in a given length of time. If, for example, you have a meter that registers the flow in gallons, you simply record the gallons at the beginning of the timed run, and then again at the end of the run. If you run for one (1) minute, you simply subtract the beginning number on the meter from the number registered after the run. This will give you the gallons per minute (GPM). Having to make this calculation is the only reason for timing the run. You can accomplish the same result by just watching the meter and stopping the system when you have totaled the desired amount of gallons through the system. In any case, you must know the amount of product passing through the system before calibration can begin.

First, change the gallons pumped into ounces by multiplying total gallons (in our example 500) by 128 (128 oz. to a gallon). The answer is 64,000 ounces.

Second, divide by 1,000,000. The answer is .06. Since you are dealing in

1/1,000,000 (one part per million) of the total for your ratio, you must find out what 1/1,000,000 of the 500 gallons is, .06 ounces is 1/1,000,000th (one part per million) of 500 gallons.

Third, multiply the .06 x 250 (for 250 PPM ratio). The answer is 15 ounces.

So, you should collect 15 ounces of additive for every 500 gallons of fuel pumped.

These are all large, round numbers. You may, for example, only be running at 100 GPM, not 500. Use the same procedure, just change the numbers to fit your application.

No two systems will ever perform exactly the same. For this reason, the procedures given for calibration are general in nature. Obviously, it is impossible to provide a graph or table that would be absolutely accurate in every case. With that in mind, all tables and graphs should be used as general guidelines. Remember, the calculated, timed and measured output that you gather is absolute. Trust your figures and your calculations.

# Hammonds Model 1600-1P7 Injection System Manual

## NORMAL OPERATION

Following initial start up and calibration, the system requires very little attention other than making certain that additive tank levels are maintained. Operators will quickly become accustomed to the performance of the system by observing the Suction Sight Flow Indicators. On-spec injection will cause a certain response in the indicators, and with some practice, operators will be able to observe the system at a glance. *This does not mean that system calibration should not be periodically checked!* However, during a

busy workload, these visual checks will provide assurance to the operator that the system is functioning.

Assuming the system remains set up and operating at least intermittently, calibration is required perhaps every 1 – 3 months. Good record keeping of additive inventory and use levels compared to fuel handled can give a good indication that additive is on specification. Test such as the refractometer for FSII content should be the final test to verify additive injection ratios.

## ADDITIVE CHART

GALLONS	135 PPM	270 PPM	1000 PPM
100	1.7 OZ.	3.4 OZ.	12.8 OZ.
200	3.4 OZ.	6.9 OZ.	25.6 OZ.
400	6.9 OZ.	13.8 OZ.	51.2 OZ.
500	8.6 OZ.	17.2 OZ.	64.0 OZ.
700	12.0 OZ.	24.0 OZ.	89.6 OZ.
1000	17.2 OZ.	34.5 OZ.	128.0 OZ.

# Hammonds Model 1600-1P7 Injection System Manual

## TROUBLESHOOTING THE SYSTEM

The following conditions are given as a means of troubleshooting the system. Each condition lists a number of possible causes. In most cases, trouble can be solved by the use of this section. Please read it carefully before attempting repairs or making changes in the system.

### FLUID MOTOR IS NOT TURNING

- A. Insufficient flow to turn the motor. A minimum of about 300 GPM must be present to start the system.
- B. A rag or some other object is jammed in the line preventing the fluid motor from turning.
- C. A diverter valve is blocked downstream of the system, blocking the fuel flow through the system.
- D. A valve is closed upstream of the fluid motor starving the product flow.
- E. If the unit has been recently serviced internally, or it is new, the rotor might be installed backwards. Consult the factory before disassembly.

### INJECTOR IS TURNING AND PUMP IS RUNNING, BUT WITH NO OUTPUT

- A. Pump is air-locked. In some cases where there is a very long line running from the injector head and the point of injection into the system, there is sufficient air volume to cause the pump to act as a compressor. It is not able to open the valves throughout the system and therefore, cannot pull a suction of fluid to the pump. Loosen the connection at the injection point check valve and allow it to remain open until the pump begins pumping. This is rare, but can happen in some cases of unusual installations.
- B. One or more of the suction or discharge check valves is not working. While the pump is running, tap on the side of the valves, one at a

time. This will generally jar them loose. The poppet and seals are very small, and will sometimes become stuck. After the valve is loosened and has a supply of fluid, usually it will not stick again.

- C. The pump is not getting additive. Check the valve between the pump and the tank. Check all connections in the line between the pump and the tank.
- D. The vent on the tank is not open causing the pump to pull a vacuum. Open the vent. Check to see if the cap has been removed from the dryer cartridge, if so equipped.
- E. The pump stroke is set at zero. Check to see if the locking screws have been left loose, allowing the adjustment knobs to rotate to zero percent (0%) of stroke.
- F. The additive tank is empty...don't laugh, it happens.

### THE INJECTOR IS OPERATING BUT WITH REDUCED OUTPUT

- A. Leaking suction line or trash in discharge check valve.
- B. Air leak in suction side of system.
- C. Defective tubing or piping on suction side.
- D. Leaks in threaded connections - suction side.
- E. If so equipped, a relief valve on injector may be bleeding part of the output back to suction. Relief valve may not be working, or retaining nut may have vibrated loose causing valve to fail entirely, bleeding output back to suction.
- F. Injector diaphragm may be pulled out in back causing injector to pump in forward portion of stroke only. This will not create a visible leak but will reduce output by 50%. It usually happens after many hours of operation.
- G. Fluid motor vanes are badly worn. This would only be probable after a very high number of hours of operation.

# Hammonds Model 1600-1P7 Injection System Manual

## PREVENTIVE MAINTENANCE

1. Make certain to use only clean, fresh additive that has been stored in a sealed container. Most additives are moisture sensitive. Some will form heavy crystals if allowed to accumulate moisture. These crystals will stop the pump in very short order, if not cause calibration to be changed due to clogging of the valves and other parts.
2. Check the additive filter screen at least every six months. More often if there is an indication of possible contamination.
3. Check the system for leaks at every use. This is an extremely important safety procedure, since some additives are flammable, caustic and corrosive.
4. Check for leaks from the seal that is located at the exit point of the injector output shaft in the side plate housing. This should be done at each operation. Leakage at this point usually indicates that the mechanical seal inside the rotor housing is leaking. A leak here will be fuel, and is not only dangerous from a fire standpoint, but will quickly ruin the bearings on the rotor shaft, since all lubricant will be washed away.
5. Check the fittings for leakage around the suction strainer or sight flow indicator, if one is used on the pump. Check this fitting each time the filter is changed or cleaned. Make certain there are no leaks in the suction line. A very small leak will either change the operation of the pump or prevent it from operating all together.

6. Visually check around the pump head and make certain there is no leaking of additive around the fluid ends. If there is, check the tightness of the head bolts. (40 inch pounds each)
7. Check the grease around the eccentric drive bearing in the pump every 6 months. Use a good quality white lithium spray lubricant.
8. It is recommended that the injector diaphragm be changed at least every 12 months. Every 6 months under extreme operating conditions. Doing so will prevent unexpected failures and unscheduled downtime.

Hammonds injectors are very dependable. If installed properly and sized appropriately to the application, they require very little maintenance. Remember, keep the additive clean, and the suction strainer clean. If you have problems with the pump working, it is usually in the suction side of the system (between the injection pump and the additive tank). Suction lines and fittings are notorious for leaking just enough to prevent the system from working. Always check to ensure optimum suction conditions should problems occur.

Remember, a leak in the suction allows air from the outside to be introduced into the system. It does not always mean a visible leak of additive. If the pump loses its prime or output is erratic, chances are good that there are problems in the suction side. Otherwise, if it is working...leave it alone!!!!

# Hammonds Model 1600-1P7 Injection System Manual

## PREVENTATIVE MAINTENANCE SCHEDULE

**NOTE:** It is important to read the previous pages on preventative maintenance. These intervals are general, and may vary according to individual applications and severity of service.

<b>SERVICE FUNCTION</b>	<b>0-4 HRS DAILY</b>	<b>5-8 HRS DAILY</b>	<b>8+HRS DAILY</b>
Check gear oil level (if equipped with worm gear reducer)	Monthly	Monthly	Monthly
Check additive filter screen	Monthly	Monthly	Monthly
Check system for additive/fuel leaks	Daily	Daily	Daily
Inspect diaphragms/plunger seals	12 Months	6 Months	3 Months
Replace diaphragms/plunger seals	12 Months	As needed	As needed
Check eccentric bearing grease	6 Months	3 Months	Monthly
Check stroke adjustment parts for looseness	Monthly	Monthly	Monthly
Replace stroke adjustment parts	24 Months	As needed	As needed
Disassemble and inspect turbine housing and internal parts	24 Months	12 Months	8 Months
Grease bearings	12 Months	6 Months	3 Months

## DESICCANT DRYER

Your Hammonds additive system may include a custom additive tank. The additive tank may come equipped with a desiccant dryer cartridge. These units come in several different sizes.

Most systems come equipped with the standard 3/4" cartridge. This unit is attached to the tank via a short length of black rubber hose. The cartridge has a housing constructed of a clear poly material and is filled with a blue colored desiccant crystal. All these units are shipped from the factory with a small yellow cap on the unattached end of the cartridge.

Some systems may come equipped with a large canister measuring approximately 2" diameter and 10" in length. These units perform the same function, just on a larger scale. Due to their greater capacity, they last longer between service. These units are sealed from the factory by a small, plastic plug which is located either on the bottom or one side of the canister.

The purpose of all desiccant dryers is simply to remove moisture from the air as the system breathes. All tanks or portable sources of additive supply must be vented to atmosphere in order for the injector to operate. If moisture in this venting air is not removed, some additives are either ruined or seriously damaged. Fuel system icing inhibitor (FSII), for example, is designed to seek out water in a fluid. So, when enough moisture is absorbed into the container, the FSII is diluted and at some point will be ruined. Biobor® JF, an anti-fungal material, will form crystals in the presence of moisture and not only perform unsatisfactorily as an additive, but will stop up pumps and lines as well.

The following instructions apply to all desiccant cartridges:

A. Remove the yellow cap or plug when the system is placed into service.

## Hammonds Model 1600-1P7 Injection System Manual

B. Observe the color of the desiccant. The original color is blue. As moisture is absorbed, the color will change to pink. When the cartridge is completely pink, it should either have its contents removed, dried and replaced, or the entire unit replaced.

**C. NOTE:** The contents can be removed from plastic container, placed on a pan and baked at 400°F in a conventional oven until the moisture has been removed. When the color blue returns, the cooled material may be reinstalled into plastic containers and is again ready for service.

Color change and cartridge life is totally dependent on humidity. The more moist the air, the shorter the life. Keeping it dry is especially important if additive is not consumed rapidly. Check daily and service as needed.

# Hammonds Model 1600-1P7 Injection System Manual

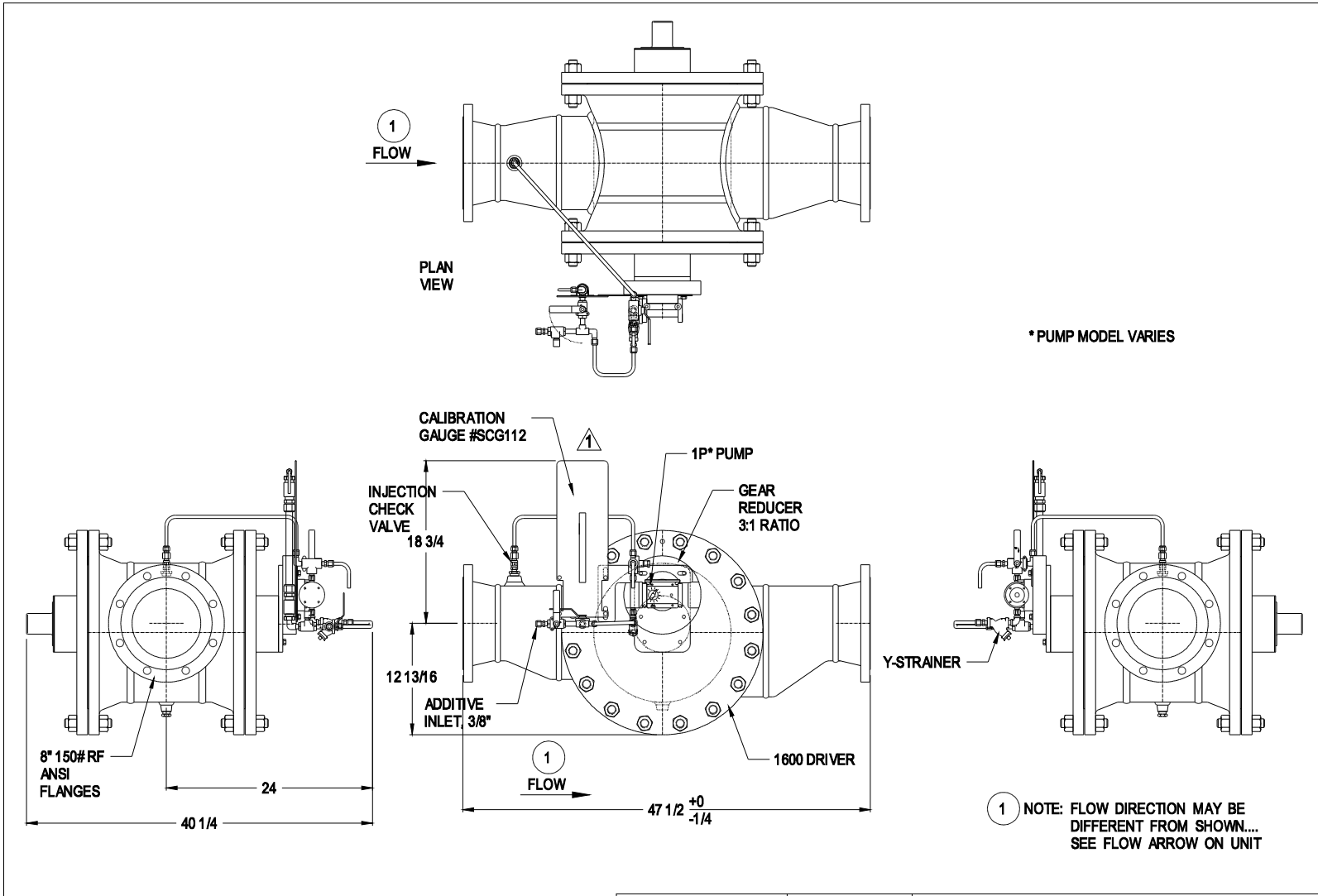

<table border="1" style="width: 100%; border-collapse: collapse;"> <tr> <td style="width: 15%;">DRAWING</td> <td style="width: 25%;">LEVELS</td> <td style="width: 15%;">VIEW</td> <td colspan="2"></td> </tr> <tr> <td>2739</td> <td>100-102</td> <td>1</td> <td colspan="2"></td> </tr> </table>					DRAWING	LEVELS	VIEW			2739	100-102	1			<p><b>*TOLERANCES*</b> ALL DIMENSIONS ARE IN INCHES UNLESS OTHERWISE SPECIFIED.</p> <p>*TOL. DECIMALS: .XXX = +/- .005 .XX = +/- .015 .X = +/- .030 FRAC. = +/- 1/16</p> <p>*TOL. ANGLES: +/- .5 DEGREES</p> <p>*CONCENTRICITY: .005 T.I.R.</p> <p>*REMOVE BURRS AND BREAK EDGES .005 MIN.</p>		<p>THIS PRINT IS CONFIDENTIAL AND IS THE PROPERTY OF HAMMONDS TECHNICAL SERVICES</p> <p>THIS PRINT SHALL NOT BE USED, COPIED OR REPRODUCED IN WHOLE OR IN PART NOR SHALL THE CONTENTS BE RELEASED IN ANY MANNER TO ANYONE UNLESS WRITTEN PERMISSION IS OBTAINED FROM HAMMONDS TECHNICAL SERVICES.</p>		<p><b>HAMMONDS TECHNICAL SERVICES, INC.</b></p>														
					DRAWING	LEVELS	VIEW																										
2739	100-102	1																															
<table border="1" style="width: 100%; border-collapse: collapse;"> <tr> <td>SCALE</td> <td>NTS</td> <td>APPROVED PART NUMBER</td> <td colspan="2">DRAWN BY SS</td> </tr> <tr> <td>DATE</td> <td>08/11/16</td> <td>.</td> <td colspan="2">REVISED 09/02/16</td> </tr> </table>		SCALE	NTS	APPROVED PART NUMBER	DRAWN BY SS		DATE	08/11/16	.	REVISED 09/02/16																							
SCALE	NTS	APPROVED PART NUMBER	DRAWN BY SS																														
DATE	08/11/16	.	REVISED 09/02/16																														
<table border="1" style="width: 100%; border-collapse: collapse;"> <tr> <td style="width: 15%;">NO.</td> <td style="width: 15%;">REVISION</td> <td style="width: 15%;">DATE</td> <td style="width: 15%;">BY</td> <td style="width: 15%;">APPVD</td> </tr> <tr> <td>1</td> <td>MOVED SCG112</td> <td>09/02/16</td> <td>SS</td> <td>X</td> </tr> <tr> <td>2</td> <td>INITIAL RELEASE</td> <td>08/11/16</td> <td>SS</td> <td>X</td> </tr> </table>					NO.	REVISION	DATE	BY	APPVD	1	MOVED SCG112	09/02/16	SS	X	2	INITIAL RELEASE	08/11/16	SS	X	<table border="1" style="width: 100%; border-collapse: collapse;"> <tr> <td>FROM SER#</td> <td>DATE</td> <td>TO SER#</td> <td>DATE</td> </tr> <tr> <td>X</td> <td>X</td> <td>X</td> <td>X</td> </tr> </table>		FROM SER#	DATE	TO SER#	DATE	X	X	X	X			<p>DRAWING TITLE <b>HAMMONDS MODEL 1600-1P*</b></p>	
NO.	REVISION	DATE	BY	APPVD																													
1	MOVED SCG112	09/02/16	SS	X																													
2	INITIAL RELEASE	08/11/16	SS	X																													
FROM SER#	DATE	TO SER#	DATE																														
X	X	X	X																														
					<p>8"150#RF, SCG112</p>		<p>DRAWING NUMBER <b>7419</b></p>																										

# Hammonds Model 1600-1P7 Injection System Manual

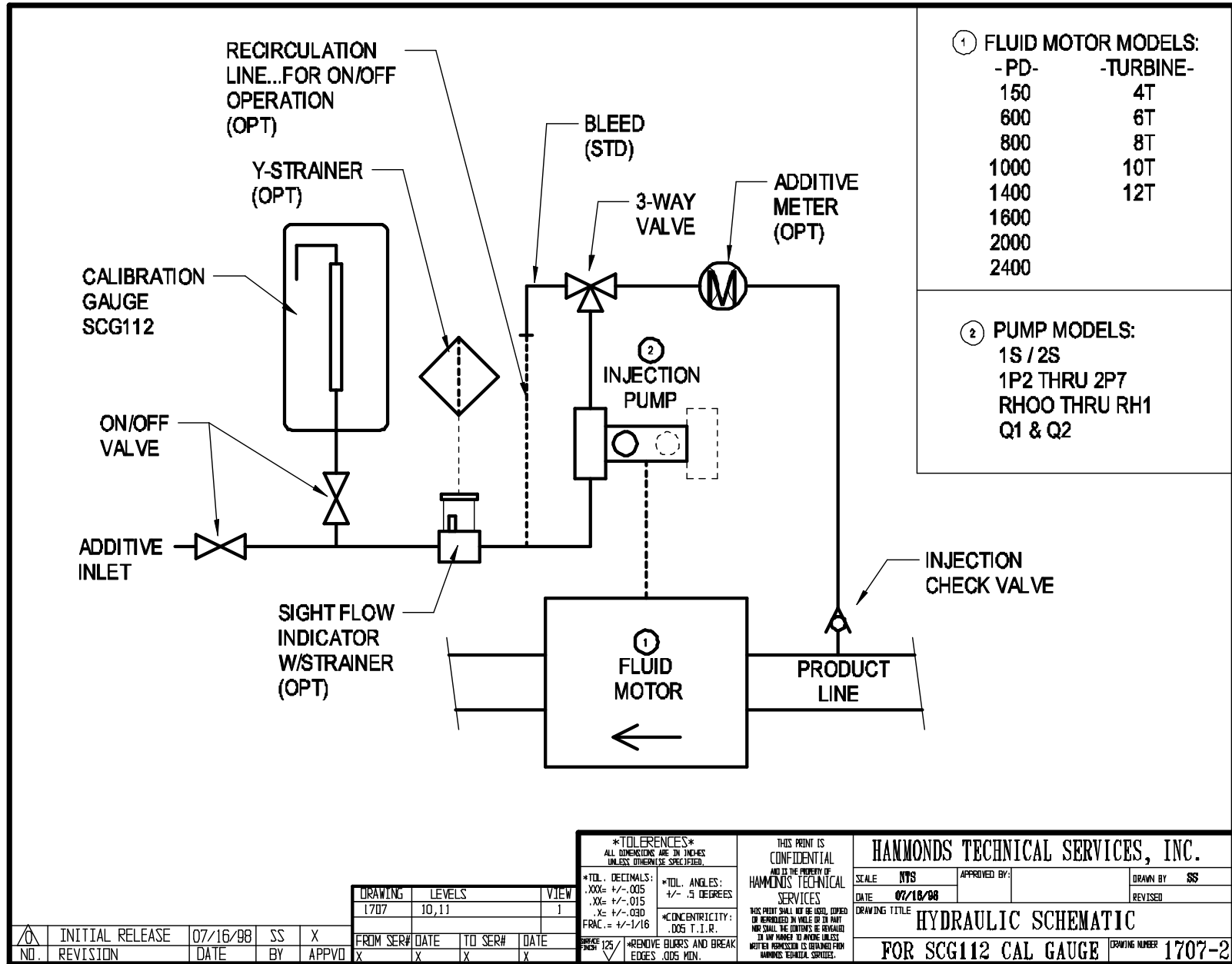

/0	INITIAL RELEASE	07/16/98	SS	X
NO.	REVISION	DATE	BY	APPV

DRAWING	LEVELS	VIEW	
1707	10,11	1	
FROM SER#	DATE	TO SER#	DATE
X	X	X	X

**\*TOLERANCES\***  
 ALL DIMENSIONS ARE IN INCHES UNLESS OTHERWISE SPECIFIED.

\*TOL. DECIMALS:  
 .XXX= +/- .005  
 .XX= +/- .015  
 .X= +/- .030  
 FRAC.= +/- 1/16

\*TOL. ANGLES:  
 +/- .5 DEGREES

\*CONCENTRICITY:  
 .005 T.I.R.

\*REMOVE BURRS AND BREAK EDGES .005 MIN.

BRASS FINISH 125

THIS PRINT IS CONFIDENTIAL AND IS THE PROPERTY OF HAMMONDS TECHNICAL SERVICES

THIS PRINT SHALL NOT BE USED, COPIED OR REPRODUCED IN WHOLE OR IN PART WITHOUT PERMISSION OF HAMMONDS TECHNICAL SERVICES.

**HAMMONDS TECHNICAL SERVICES, INC.**

SCALE: NTS	APPROVED BY:	DRAWN BY: SS
DATE: 07/18/98		REVISED:

DRAWING TITLE: **HYDRAULIC SCHEMATIC**

**FOR SCG112 CAL GAUGE** DRAWING NUMBER: 1707-2

# Hammonds Model 1600-1P7 Injection System Manual

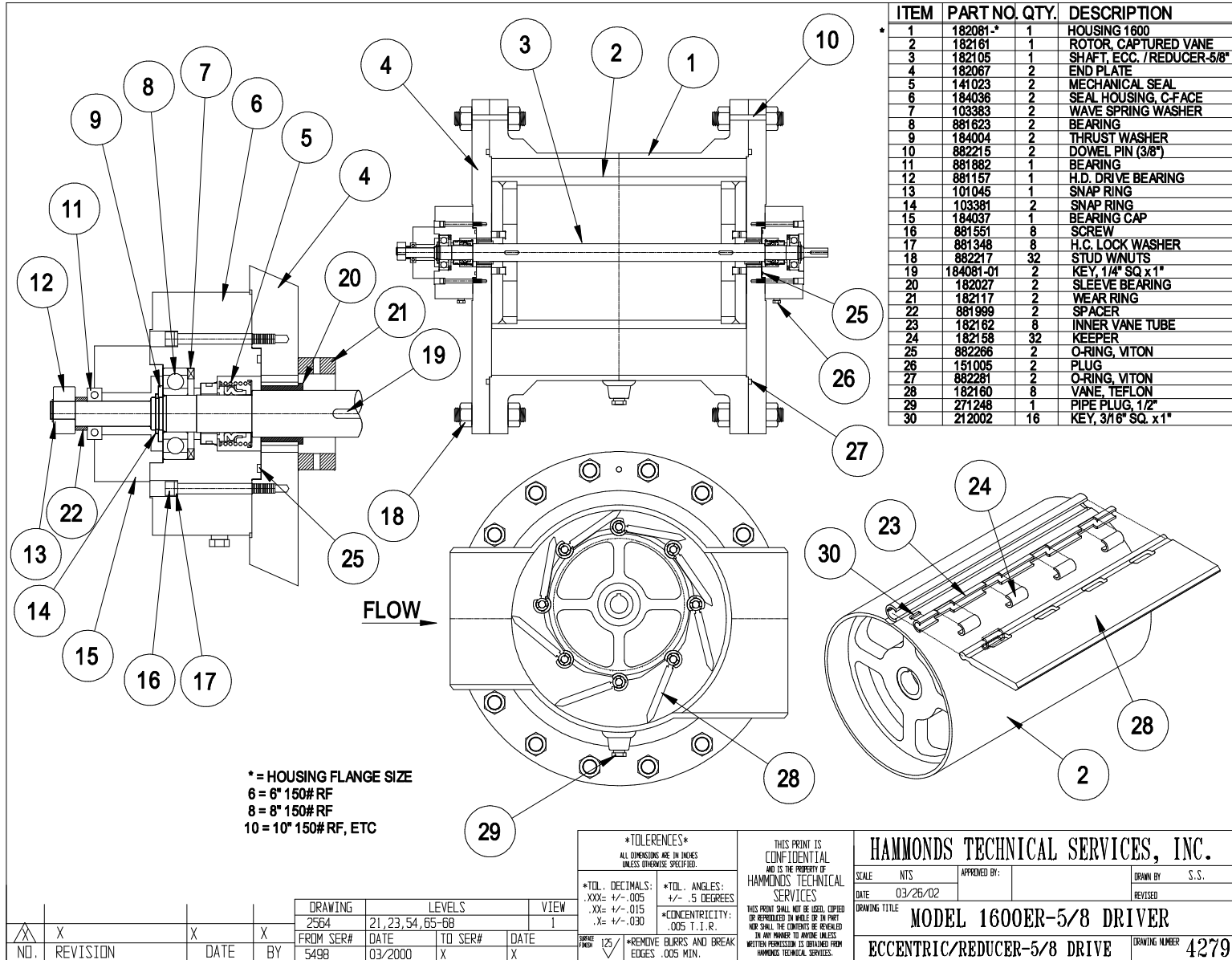

*TOLERANCES* ALL DIMENSIONS ARE IN INCHES UNLESS OTHERWISE SPECIFIED:		THIS PRINT IS CONFIDENTIAL AND IS THE PROPERTY OF HAMMONDS TECHNICAL SERVICES		SCALE: NTS APPROVED BY: _____ DATE: 03/26/02 DRAWN BY: S.S. REVISED: _____																		
*TOL. DECIMALS: .XXX= +/- .005 .XX= +/- .015 .X= +/- .030	*TOL. ANGLES: +/- .5 DEGREES *CONCENTRICITY: .005 T.I.R.	THIS PRINT SHALL NOT BE USED, COPIED OR REPRODUCED IN WHOLE OR IN PART NOR SHALL THE CONTENTS BE REPRODUCED IN ANY MANNER TO ANYONE UNLESS WRITTEN PERMISSION IS OBTAINED FROM HAMMONDS TECHNICAL SERVICES.																				
<table border="1" style="width: 100%; border-collapse: collapse;"> <thead> <tr> <th>DRAWING</th> <th>LEVELS</th> <th>VIEW</th> </tr> </thead> <tbody> <tr> <td>2564</td> <td>21, 23, 54, 65-68</td> <td>I</td> </tr> <tr> <th>FROM SER#</th> <th>DATE</th> <th>TO SER#</th> <th>DATE</th> </tr> <tr> <td>5498</td> <td>03/2000</td> <td>X</td> <td>X</td> </tr> </tbody> </table>		DRAWING	LEVELS	VIEW	2564	21, 23, 54, 65-68	I	FROM SER#	DATE	TO SER#	DATE	5498	03/2000	X	X	<table border="1" style="width: 100%; border-collapse: collapse;"> <tr> <td style="font-size: x-small;">           *REMOVE BURRS AND BREAK            EDGES .005 MIN.         </td> <td style="font-size: x-small;">           SURFACE            FINISH 125 ✓         </td> </tr> </table>		*REMOVE BURRS AND BREAK EDGES .005 MIN.	SURFACE FINISH 125 ✓	<b>HAMMONDS TECHNICAL SERVICES, INC.</b> <b>MODEL 1600ER-5/8 DRIVER</b> <b>ECCENTRIC/REDUCER-5/8 DRIVE</b>		DRAWING NUMBER <b>4279</b>
DRAWING	LEVELS	VIEW																				
2564	21, 23, 54, 65-68	I																				
FROM SER#	DATE	TO SER#	DATE																			
5498	03/2000	X	X																			
*REMOVE BURRS AND BREAK EDGES .005 MIN.	SURFACE FINISH 125 ✓																					

# Hammonds Model 1600-1P7 Injection System Manual

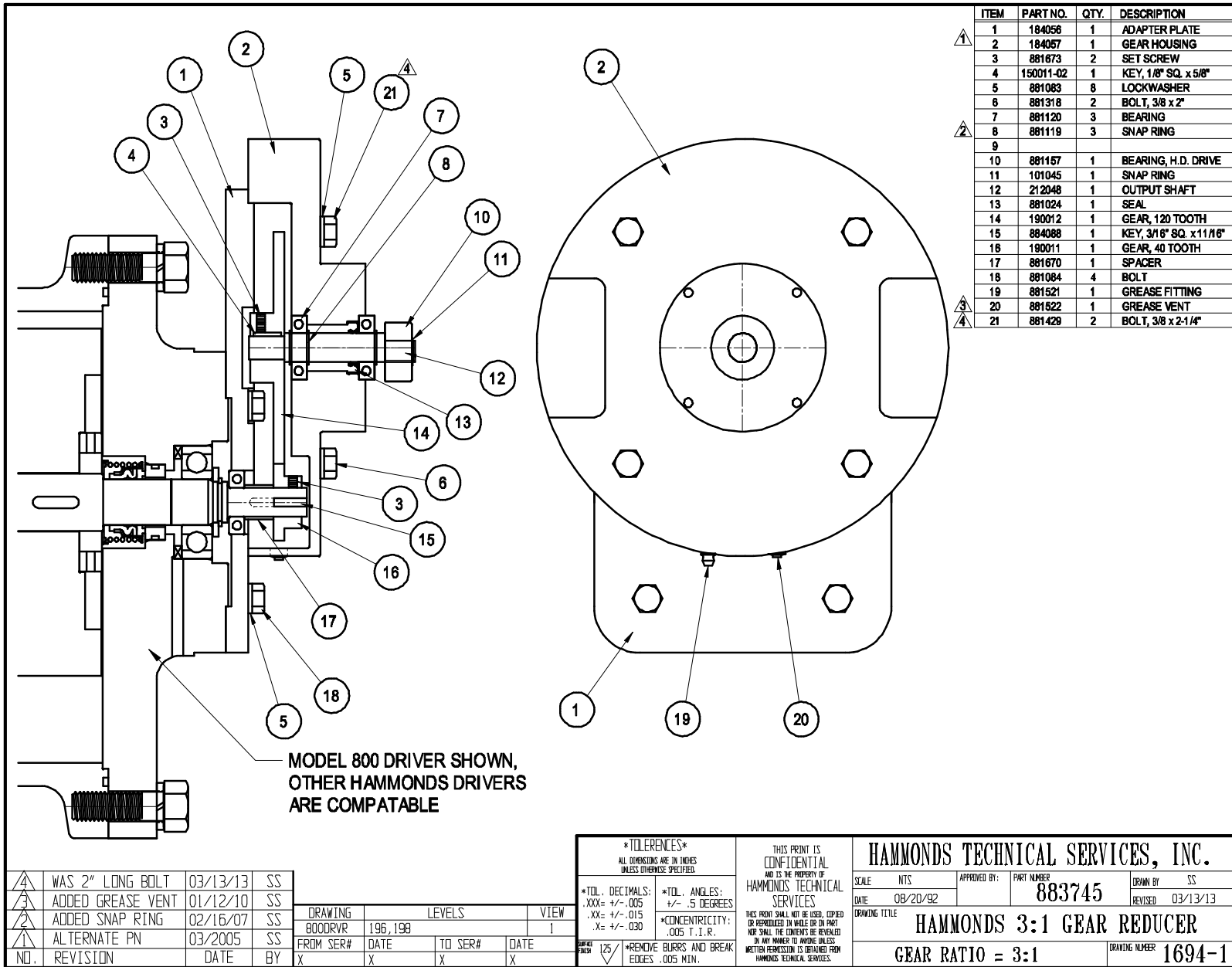

⚠	WAS 2" LONG BOLT	03/13/13	SS
⚠	ADDED GREASE VENT	01/12/10	SS
⚠	ADDED SNAP RING	02/16/07	SS
⚠	ALTERNATE PN	03/2005	SS
NO.	REVISION	DATE	BY

DRAWING	LEVELS	VIEW
800DRVR	196, 199	1
FROM SER#	DATE	TO SER#
X	X	X

**\*TOLERANCES\***  
ALL DIMENSIONS ARE IN INCHES UNLESS OTHERWISE SPECIFIED.

*TOL. DECIMALS: .XXX = +/- .005 .XX = +/- .015 .X = +/- .030	*TOL. ANGLES: +/- .5 DEGREES
*CONCENTRICITY: .005 T.I.R.	

REMOVE BURRS AND BREAK EDGES .005 MIN.

THIS PRINT IS CONFIDENTIAL AND IS THE PROPERTY OF HAMMONDS TECHNICAL SERVICES

THIS PRINT SHALL NOT BE USED, COPIED OR REPRODUCED IN WHOLE OR IN PART NOR SHALL THE CONTENTS BE REVEALED IN ANY MANNER TO ANYONE UNLESS WRITTEN PERMISSION IS OBTAINED FROM HAMMONDS TECHNICAL SERVICES.

<b>HAMMONDS TECHNICAL SERVICES, INC.</b>			
SCALE: NTS	APPROVED BY:	PART NUMBER: 883745	DRAWN BY: SS
DATE: 08/20/92			REVISED: 03/13/13
DRAWING TITLE: <b>HAMMONDS 3:1 GEAR REDUCER</b>			
GEAR RATIO = 3:1			DRAWING NUMBER: 1694-1

# Hammonds Model 1600-1P7 Injection System Manual

26	882352	2	LOCK WASHER, 5/16" SS (OPTION)
27	883863	2	SCREW, 5/16-18 x 1 1/4" SS (OPTION)
27A	882351	2	SCREW, 5/16-18 x 2 3/4" SS (OPTION)
28	102480	2	O-RING (OPTION)
29	102747A	1	DUST CAP STD. (OPTION)
	102747	1	DUST CAP (FOR OPTION O-RING)
30	101388	1	O-RING (FOR 102747 OPTION)
31	102746	1	DUST PLUG (OPTION)

ITEM	PART NO.	QTY.	DESCRIPTION
1	102757	1	POWER FRAME, HD ALUM.
2	881045	1	SETSCREW, 1/4-20 x 1 (PART OF #3)
3	102192	1	PLUNGER, P7
4	881765	1	SEAL, LIP
5	101749	1	1/8" FILTER (OPTION)
6	102194	1	SEAL HOUSING
6A	102474	1	SEAL HOUSING, VENTED (OPTION)
7	101490	1	O-RING, AFLAS
	101226	1	O-RING, VITON (OPTION)
	101754	1	O-RING, KALREZ (OPTION)
8	102193	1	FLUID END, P7
9	882949	12	LOCK WASHER, #10 INTERNAL
10	881317	4	SCREW, #10-32 x 2"
11	102483	2	CHECK VALVE, AFLAS
	102464	2	CHECK VALVE, VITON (OPTION)
	102642	2	CHECK VALVE, KALREZ (OPTION)
12	101007	2	RETURN SPRING
13	101006	1	CROSSHEAD
14	101152	2	SLIDE BEARING
15	101005	1	STROKE ADJUSTMENT CAM
16	102758	1	PUMP FRAME COVER, HD ALUM
17	101670	1	STROKE INDICATOR
18	101037	2	SCREW, #10-32 x 1 1/2"
19	881126	4	SCREW, #10-32 x 1/2"
19A	881126	4	SCREW, #10-32 x 1/2" (OPTION)
20	101001	1	STROKE ADJUSTMENT KNOB
21	101749	1	1/8" FILTER (OPTION)
22	881301	4	SCREW, #10-32 x 1"
22A	883170	4	SCREW, #10-32 x 2 1/2" (OPT)
23	101038	4	LOCK WASHER, #10 H.C.
24	882911	1	CHECK VALVE, 5 PSI, AFLAS
	101576	1	CHECK VALVE, 5 PSI, VITON (OPT)
	102643	1	CHECK VALVE, 5 PSI, KALREZ (OPT)
25	101088	1	3/8 x 1/4 FNPT TUBE ADAPT.

ADDED STD DUST CAP	09/30/16	SS	X	
INITIAL RELEASE	02/16/07	SS	X	
ND.	REVISION	DATE	BY	APPVD

DRAWING	LEVELS		
INJECTOR	40, 90-93, 95-97, 129, 139-141		
	143, 208, 210, 239, 242, 243		
FROM SER#	DATE	TO SER#	DATE
X	X	X	X

**\*TOLERANCES\***  
ALL DIMENSIONS ARE IN INCHES UNLESS OTHERWISE SPECIFIED.

\*TOL. DECIMALS:  
.XXX= +/- .005  
.XX= +/- .015  
.X= +/- .030  
FRAC = +/- 1/16

\*TOL. ANGLES:  
+/- .5 DEGREES

\*CONCENTRICITY:  
.005 T.I.R.

\*REMOVE BURRS AND BREAK EDGES .005 MIN.

THIS PRINT IS CONFIDENTIAL AND IS THE PROPERTY OF HAMMONDS TECHNICAL SERVICES

THIS PRINT SHALL NOT BE USED, COPIED OR REPRODUCED IN WHOLE OR IN PART NOR SHALL THE CONTENTS BE REVEALED TO ANY NUMBER TO WHOME UNLESS WRITTEN PERMISSION IS OBTAINED FROM HAMMONDS TECHNICAL SERVICES.

HAMMONDS TECHNICAL SERVICES, INC.	
SCALE: NTS	APPROVED PART NUMBER
DATE: 02/16/07	REVISIONS: 08/30/16
DRAWING TITLE: HAMMONDS 1P7 PUMP	
HEAVY DUTY	DRAWING NUMBER: 5550

# Hammonds Model 1600-1P7 Injection System Manual

ITEM	PART NO.	QTY.	DESCRIPTION
1	101014	1	POWER FRAME
2	102192	1	PLUNGER, P7
3	102193	1	FLUID END, P7
4	882949	8	LOCK WASHER, #10 INT. TOOTH
5	881317	4	SCREW, 10-32 x 2"
6	101842	1	CROSSHEAD GUIDE
7	101007	2	RETURN SPRING
8	101006	1	CROSSHEAD
9	101152	2	SLIDE BEARING
10	101005	1	STROKE ADJUSTMENT CAM
11	101003	1	CAM GUIDE
12	101001	1	STROKE ADJUSTMENT KNOB
13	101002	1	POWER FRAME COVER
14	101004	1	LOCK SCREW
15	101009	4	SCREW, 8-32 x 3/8"
16	881086	4	LOCKWASHER, #6
17	101010	4	SCREW, 6-32 x 3/8"
18	881089	4	SCREW, 10-32 x 3/4"
18A	881660	4	SCREW, 10-32 x 2 1/4" (OPTION)
19	102463	2	CHECK VALVE, AFLAS
	102464	2	CHECK VALVE, VITON (OPTION)
	102642	2	CHECK VALVE, KALREZ (OPTION)
20	101490	1	O-RING, AFLAS
	101226	1	O-RING, VITON (OPTION)
	101754	1	O-RING, KALREZ (OPTION)
21	102194	1	SEAL HOUSING
22	881765	1	SEAL, LIP
23	881045	1	SETScrew, 1/4-20 x 1"
24	882911	1	CHECK VALVE, 5 PSI, AFLAS, STD.
	101576	1	CHECK VALVE, 5 PSI, VITON, (OPT)
	102643	1	CHECK VALVE, 5 PSI, KALREZ, (OPT)
25	101088	1	3/8 x 1/4 FNPT TUBE ADAPT.

6	ADDED PART NOS.	01/21/14	SS
5	WAS #101671	03/15/04	SS
4	WAS #101933	03/15/04	SS
3	WAS #102263	09/03/02	SS
2	WAS #101008	08/99	SS
1	ADDED INJ CHK VLV	01/06/98	SS
NO.	REVISION	DATE	BY

DRAWING	LEVELS	VIEW
INJECTOR	10, 12, 14, 16, 18, 20, 24, 28, 30	I
FROM SER#	DATE	TO SER#
X	X	X

**\*TOLERANCES\***  
ALL DIMENSIONS ARE IN INCHES UNLESS OTHERWISE SPECIFIED.

\*TOL. DECIMALS:  
.XXX = +/- .005  
.XX = +/- .015  
.X = +/- .030  
FRAC. = +/- 1/16

\*TOL. ANGLES:  
+/- .5 DEGREES

\*CONCENTRICITY:  
.005 T.I.R.

\*REMOVE BURRS AND BREAK EDGES .005 MIN.

THIS PRINT IS CONFIDENTIAL AND IS THE PROPERTY OF HAMMONDS TECHNICAL SERVICES

THIS PRINT SHALL NOT BE USED, COPIED OR REPRODUCED IN WHOLE OR IN PART IN ANY MANNER TO AVOID UNLESS WRITTEN PERMISSION IS OBTAINED FROM HAMMONDS TECHNICAL SERVICES.

**HAMMONDS TECHNICAL SERVICES, INC.**

SCALE: NTS	APPROVED: PART NUMBER	DRAWN BY: SS
DATE: 05/11/93		REVISED: 01/21/14
DRAWING TITLE: <b>HAMMONDS 1P7 PUMP ASSEMBLY</b>		
		DRAWING NUMBER: <b>1911</b>



