

**OPERATING INSTRUCTIONS
AND
MAINTENANCE MANUAL
FOR
HAMMONDS MODEL 600ER-1M-1P2-1P2
FLUID POWERED
ADDITIVE INJECTOR SYSTEM**

Manufactured by:



HAMMONDS TECHNICAL SERVICES, INC.

6807 West Little York Rd.
Houston, Texas 77040

Phone: 281-999-2900

Fax: 713-896-9419

www.hammondscos.com

February 2026

Hammonds Model 600ER-1M-1P2-1P2 Injection System Manual

TABLE OF CONTENTS

Special Notice to Users	3
Installation and Preparation for Startup	3
Installation Considerations of Bare Units	4-5
Locating the System	5-8
Additive Supply System	8-10
Additive Tank Installation	11-13
Preparation for Calibration and Startup	13-14
Calibration and Startup	14-17
Additive Chart	17
Trouble Shooting the System	17-18
Preventive Maintenance	18-19
Preventive Maintenance Schedule	20
Desiccant Dryer Instructions	20-21

Attachments:

Drawings and Parts Lists:
System Layout
Hydraulic Schematic
600ER Drive Unit Parts
Gear Reducer Parts
1M Injector Pump Parts
Diaphragm Replacement
1P2 Injector Pump Parts
Calibration Gauge Parts
Calibration Gauge Instructions

Hammonds Model 600ER-1M-1P2-1P2 Injection System Manual

SPECIAL NOTICE TO USERS PLEASE READ CAREFULLY BEFORE OPERATING EQUIPMENT

This additive injector system is designed to give consistent dependable performance when operated and maintained according to manufacturer's recommendations. However, being a mechanical device, it is subject to failure from improper installation, wear, human error and operating environments beyond the control of the system. Because of this fact, it is the responsibility of the operator to make certain that:

- A. The system is installed properly.
- B. The system is being operated properly.
- C. The system is actually running during product transfer.
- D. The system is checked after the transfer operation to make certain the proper amount of additive was injected during the operation.

The performing of these checks by the operator eliminates the possibility of product not having the proper additive ratio as required. Therefore, since the manufacturer cannot be present during each transfer operation, the responsibility for checking the performance of the system is that of the operator. Should there be any questions whatsoever, the operator should consult the distributor from whom the unit was purchased.

Do Not Take Chances.....Do Not Guess.....Be Absolutely Certain That The System Is Installed And Working As It Should.

The user/operator carries the final responsibility to make certain the system is operating properly.

INSTALLATION AND PREPARATION FOR STARTUP

In most cases, the Hammonds fluid powered injector is shipped complete and ready to operate. The system should include appropriate fittings to suit your specific application. Flow direction is marked on additive pumps and check valves. Any and all flow restricting devices such as on/off ball valves, remote panels, sight flow indicators, suction strainers or electrically controlled solenoid valves must be installed on the suction side of additive pumps. See **ON/OFF OPERATION**.

CAUTION

Do Not Attempt To Use This Device Without Understanding And Following Proper Safety Precautions Regarding System Grounding, Fire Safety, And Special Handling For Potentially Dangerous Additives.

Consult your Engineering Department for their specific instructions. Make certain all personnel involved with this system are thoroughly familiar with safe operating practices.

If your system has been purchased "bare," consult your equipment distributor for help in selecting hoses, fittings and other related accessories. Selection of materials compatibility, location of unit within the system, effect of the unit on the system and injection point of the additive are also factors that should be discussed by factory authorized personnel.

If no factory-authorized distributor is available, consult the factory directly for assistance.

Hammonds Model 600ER-1M-1P2-1P2 Injection System Manual

INSTALLATION CONSIDERATIONS OF BARE UNITS

Hammonds additive injector systems may be installed in a wide variety of applications, systems, and operating conditions. **This Manual Makes The Assumption That The Purchaser Has Consulted With A Factory Authorized Distributor Or The Factory And Has Approval For The Application And Installation.** If this is not the case, listed below are a few considerations that should be reviewed before installing a unit in an existing system.

POINT OF INJECTION OF ADDITIVE

Some additives may adversely affect other components in the product handling systems, for example seals in meters, valve seals, aluminum and filter elements to name a few. The Hammonds injector systems do an excellent job of mixing the additive in the product, and does not inject in large slugs. Because of this superior mixing and very small concentration of additive in any one point, many customers feel that this is not a problem. **SOME DO**, and therefore, should use their own judgment as to the effect of these additives. **Hammonds Technical Services, Inc. Can Only Advise You Of The Possible Hazards.** It is up to the owner to decide his preference as to location of the additive injection point. It can be placed at any point in the system. The 600 comes with the injection point directly ahead of the fluid motor for good blending. It can be located elsewhere very easily. If the injection point is moved from the body of the injector, the 1/4" tapped hole must be plugged, the inlet check valve moved to the new location, and the injection tubing rerouted to the new location. An injection check valve must always be used regardless of location.

WHERE TO PHYSICALLY MOUNT THE INJECTOR

The Model 600 can be mounted in most any convenient location. Standard product connections are 3" Victaulic® or 3" 150# RF flanges. The performance of the 600 is not effected by changes in pipe direction or other components such as valves, strainers or meters directly before or after the injector. However, care should be taken in placing the unit too close to other items such as turbine meters that may be sensitive. Consult other manufacturers for advice in placing the injector adjacent to their specific equipment.

MOUNTING ATTITUDE

The Hammonds injector can be mounted in a horizontal, vertical, or even a slanted pipe with one condition. The main motor shaft that powers the injector **MUST** always be horizontal. If this is not done, premature wear will occur in the unit, causing flow tolerances in the unit to become excessive. This will lead to a loss in the system's ability to operate correctly at low flow rates. **Study The Installation Drawing At The End Of The Manual Carefully. Consult Your Local Distributor Or The Factory If You Have Any Questions Whatsoever.**

INSTALLATION RELATIVE TO METERS

Hammonds injectors can be installed at any point in the system. If the unit is mounted downstream of the meter, the injection point may be moved upstream of the meter in order to measure the amount of additive being measured.

Hammonds Model 600ER-1M-1P2-1P2 Injection System Manual

SPACE REQUIREMENTS

The system is designed with easy service in mind. The entire rotor and pump assembly can be removed, where possible, from the housing without disturbing the system piping. Ample room should be reserved in the installation for this removal. The injector pump is removed from the side in which it is mounted. Should the fluid motor need service, it is typically done from the backside. A clearance of 12" is required on the backside to remove the rotor and rear side plate. An equal amount is necessary to remove the rotor and shaft from the front or injector side. Also, allow room for the operator to have visual access to the controls on the pump for calibration purposes.

ON/OFF OPERATION

Two methods may be used to stop or start injection. For standard diaphragm pumps a valve may be installed in the suction side of the system that acts to interrupt the flow of additive to the injector. This may be either a manual valve or solenoid operated. For best results, the valve should be located as close to the injector as possible. **Caution:** If a solenoid operated valve is used, make certain the orifice size is large enough to cause no restriction in flow of the additive. In addition, the valve **Must Be Direct Acting**. Many valves are "pilot operated," meaning that they require at least 5 PSI line pressure in the line. **This Type Of Valve Will Not Work In This Application.** Remember, the suction side of the injector may be either at a very low pressure or a slight vacuum. Therefore, a direct acting valve must be used. Make certain valve trim elastomers are

compatible with the additive. Even slight swelling of the valve seals can cause erratic operation and, in some cases, total failure of the valve.

Here is how it works. Since the injector is a diaphragm type pump, it can be operated "DRY" without damage. When the additive supply valve is turned off, the injector simply maintains a suction on the additive line until the valve is opened for operation. The injector immediately begins pumping when the valve is returned to the ON position. Most injector pumps used on the Model 600 can operate in the OFF position with the suction blocked. However, there are some special units (rotary pumps) that cannot be blocked. These will be labeled accordingly. If there are any doubts, please consult the factory.

The second method for ON/OFF operation is to provide a 3-way valve on the discharge side of the injector. One position sends output to the product line, the other sends output back to the tank. Make certain the valve used does not have a blocked center position as blocking the discharge of the injector will cause serious damage. This is the only recommended method for Rotary Pumps.

<p>NEVER, NEVER install an on/off valve on the discharge side of any pump. Turning this valve off will block the discharge of the pump, rupturing the diaphragm or plunger seal resulting in an uncontrolled leak of additive and causing catastrophic failure to the pump.</p>
--

LOCATING THE SYSTEM

In rack loading installations, there are usually several locations for installing the system.

The first choice would be remote from the island at some point in the main product line between the product pump and where the pipe

Hammonds Model 600ER-1M-1P2-1P2 Injection System Manual

goes underground or overhead, leading to the island itself. This type installation is usually used in cases where all the product handled by the island will be treated. Although the additive can be turned off, if two loading arms on the island are being used simultaneously, it is not possible to isolate one and not the other for injection.

INJECTOR LOCATION FOR OFF-ISLAND INSTALLATION

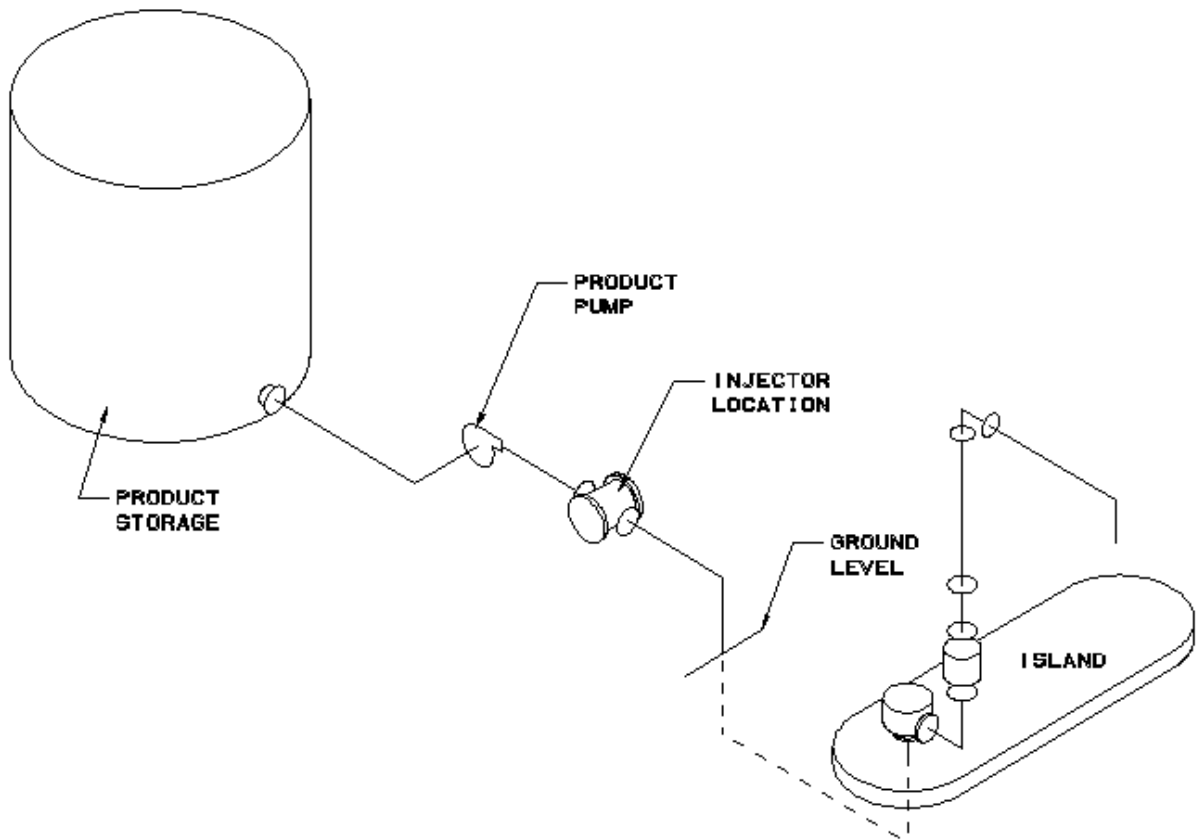

The injector should not be located between the product pump and the product storage tank.

In remote island installations such as illustrated above, positive displacement drivers can be used in either horizontal or vertical straight runs of pipe.

The other option for basic location is on the island itself. In this installation, a unit is usually placed on each of the loading arms, providing for the selective injection of any combination. The unit may be installed at any point from where the pipe exits the ground to where the swivel arm begins for the hose drop. This location offers versatility in that a single injector can be shared by up to four (4)

Hammonds Model 600ER-1M-1P2-1P2 Injection System Manual

separate users, injecting different additives on demand. There is almost always a convenient “spot” to install the system in a short run of straight-line pipe.

INJECTOR LOCATION FOR ON-ISLAND INSTALLATION

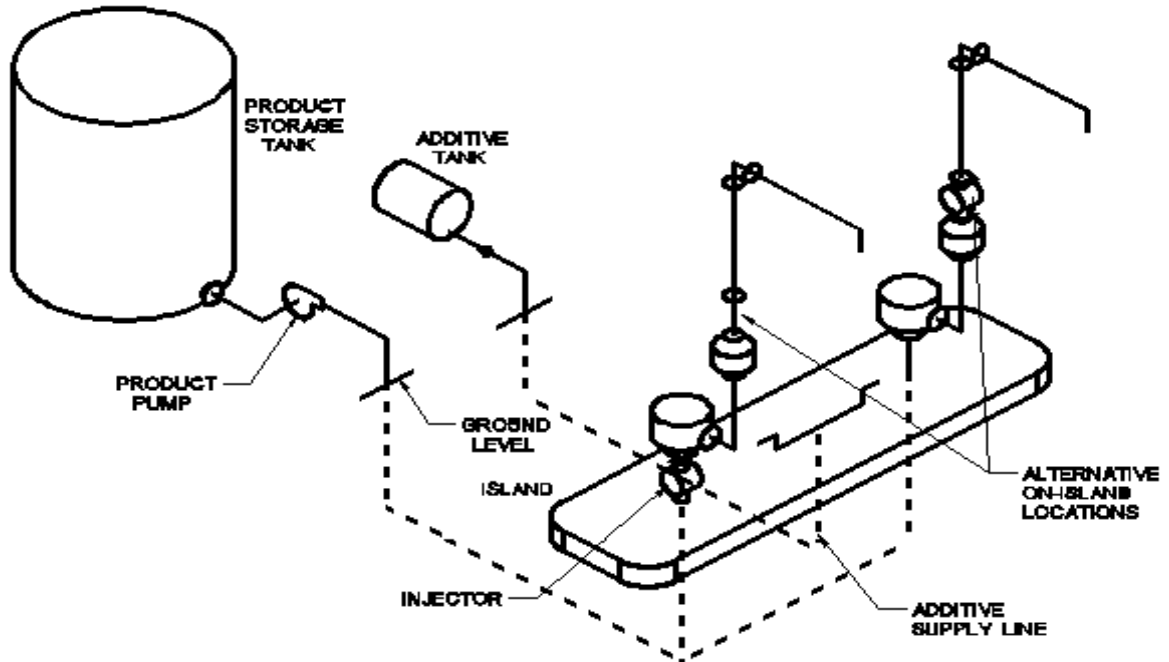

Location of the injector at the island is usually handy to existing wiring conduits for card controls, allowing for easy installation of the on/off solenoid. Units can be configured for horizontal or vertical installation.

CHOOSING THE SPOT FOR INSTALLATION OF THE UNIT ON THE ISLAND

Most island loading arms will present at least two and sometimes three mounting options. Consideration should be given to serviceability and traffic of personnel and equipment such as swinging hoses.

Hammonds Model 600ER-1M-1P2-1P2 Injection System Manual

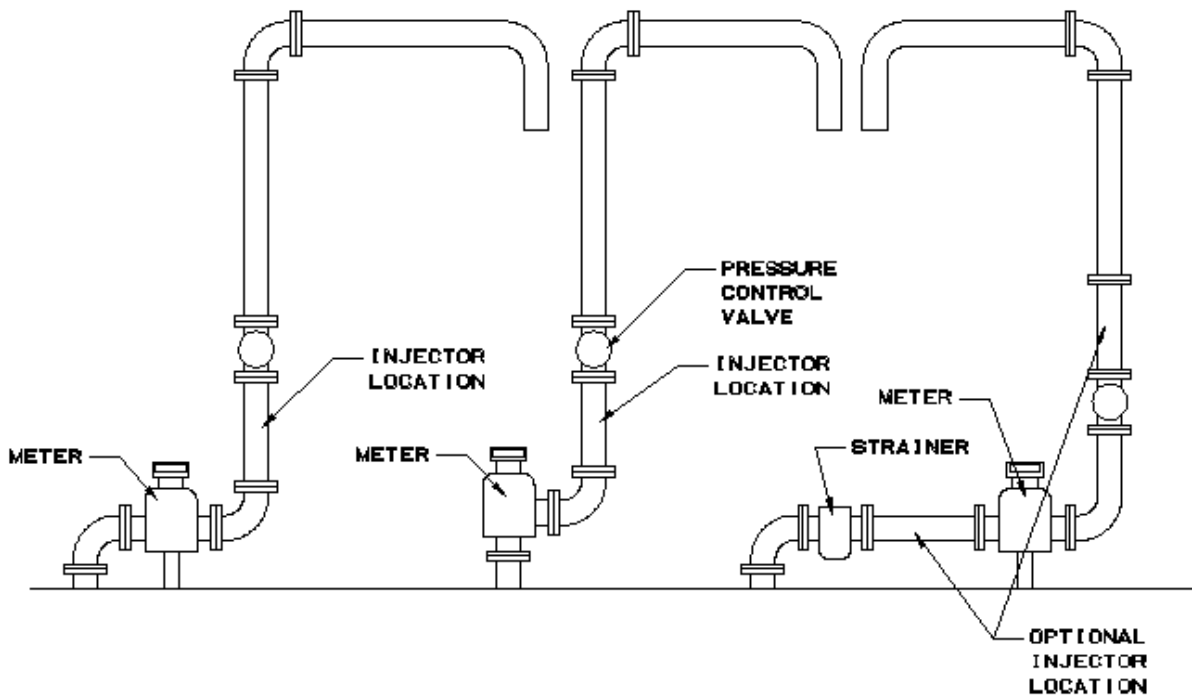

ADDITIVE SUPPLY SYSTEM

The additive tank should always be placed as close to the injector as possible. Ideally, the tank should be at the same level or slightly higher than the unit providing a flooded suction to the injector. If this is not possible, the injector, depending upon the application and the model of pump, will pull a suction lift. **NOT ALL PUMPS WILL.** The end user is responsible to make sure there are absolutely no leaks in the suction line of the injector. A pin hole will prevent the system from priming

and/or operating efficiently. Tape all connections carefully with Teflon sealant. Consult your engineering department or the factory for assistance with any application concerns.

The illustration below identifies the basic components necessary for a complete additive supply system. Study the information provided for each component, as each part plays a vital role in the overall performance of the system.

Hammonds Model 600ER-1M-1P2-1P2 Injection System Manual



A. THE ADDITIVE TANK: Additive tanks should be constructed of materials compatible with the additive. Tanks should be new and free from scale, rust and corrosion. Any loose surface material inside the tank will fall into suspension and contaminate the additive after startup. Care should be taken to prevent sandblast sand from entering the tank during the manufacturing process. If water is used for testing, the tank should be dried internally to prevent the formation of rust.

B. TANK SUCTION POINT: Suction should never be taken from the very bottom of the tank. Should foreign material of any kind be present, the line will become plugged, causing either failure or erratic performance of the system. Remember, there are components in every additive system that are sensitive to contamination. Suction should be taken at

least 1" off the bottom of the tank to prevent the introduction of foreign sediments off the bottom.

C. FILTER ON/OFF VALVE: A full opening ball valve of at least the diameter of the additive supply line should be placed on either side of the suction Y strainer. Two valves are necessary in order to clean the strainer without losing the entire line full of additive. This will prevent having to re-prime the system each time the strainer is cleaned.

D. SUCTION Y STRAINER: A large Y type strainer with a screen opening of not more than 50 is ideal for taking most harmful particles from the additive supply. Any smaller mesh will cause excessive friction loss. If the openings are too large, the strainer will do little to protect the system.

Hammonds Model 600ER-1M-1P2-1P2 Injection System Manual

E. SUCTION LINE CHECK VALVE:

Notice: *This check valve is only used in vary rare occasions. Consult the factory before use.* This suction line check valve is used to provide additional insurance that the primed line will not drain back between uses. If the additive supply line is properly installed without leaks, it will remain full even when not in use. This line check valve is suggested as an extra precaution to prevent loss of system prime. The valve should be made of a material compatible with the additive, and have a “feather light” opening pressure. The valve should be a ball type with a synthetic material that is very light, preferably with no spring. The gravity of the material will seat the ball. Consult the factory if there is any question regarding the proper valve for this application.

F. SERVICING OUTLET: The service outlet provides a means for operating a manual pump in the additive supply line. The pump can be connected and used for purging air from the line while priming. Although this is an option, the factory strongly recommends the accessory for easy startup and service. A simple tee and on/off valve is used for this purpose.

G. ADDITIVE SUPPLY LINE: The size of the delivery line to the injector is important when long distances are involved. Use the following chart for determining line size.

0 - 500 PPM up to 25'	1/2"
25 to 50'	3/4"
50 to 100'	1"

Over 1000 PPM up to 25'	3/4"
25 to 50'	1"
50 to 100'	1 1/4"

The above line sizes are a suggestion only. Make certain to use at least 1 size larger than the inlet size of the pump you are supplying. Consult the factory for greater requirements.

H. SIGHT FLOW/STRAINER VALVE:

This valve is also a full opening ball valve that is used to isolate the additive line when cleaning the strainer in the Sight Flow Indicator.

I. SIGHT FLOW INDICATOR/

SUCTION STRAINER: This strainer is used to provide indication of the system's operation, as well as add extra protection for the solenoid valve from trash and contamination. When properly installed, this indicator will give the operator proof that the system is operating properly.

J. SOLENOID VALVE:

This valve is provided for the remote operation of the system. It is important that the valve is a direct acting type that requires no pressure from the line in which it controls. The materials of the valve body and the elastomers are extremely important as any reaction with the additive can cause failures. Consult the factory to make certain that the valve and trim materials are compatible. Also, make certain that the orifice in the valve is at least 7/16", with 5/8" being ideal. Any restriction in this orifice will cause the system to work harder to perform the given ratio of injection.

Hammonds Model 600ER-1M-1P2-1P2 Injection System Manual

ADDITIVE TANK INSTALLATION

Placement of the additive tank and related supply lines relative to the injector is critical to performance of any additive system. The following illustrations will provide information regarding the various types of tank installations and their connection to the additive injectors. Hammonds injectors offer the greatest flexibility in tank and supply line installation of any additive injection system on the market. Since no pumps or feed

mechanisms are necessary, installation goes faster and at less cost. The choice of appropriate components and pipe sizes, along with leak-free installation, will determine if the system works properly and consistently.

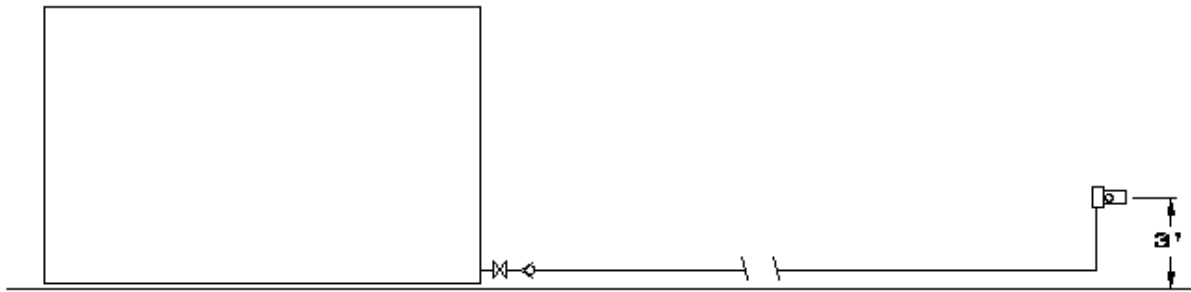

OPTION 1 - ABOVE GROUND TANK, ABOVE GROUND DELIVERY LINES

This installation calls for both the tank and the supply lines to be above ground. The bottom of the tank is very close to the ground, and the injector is approximately 3' above ground. Using a 4' diameter tank, this would provide a variable net suction head to the injector of +1' when the tank is full to a worst condition of a -3' when the tank is almost empty. A Y type strainer should be located at the tank. A full opening ball valve located on each side of the strainer, with a light action (less than 1/2 PSI) check valve installed to assist in holding the prime. Install a ball valve just upstream of the Sight Flow Indicator, and if one is to be used, install the solenoid-operated valve between the Sight Flow Indicator and the injector. Use the table listed in the previous section for selection of pipe diameter.

Hammonds Model 600ER-1M-1P2-1P2 Injection System Manual

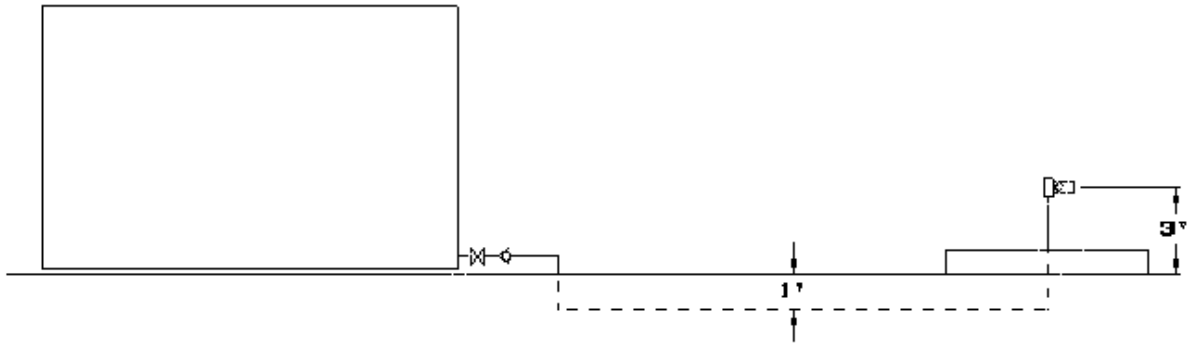

OPTION 2 - ABOVE GROUND TANK, BELOW GROUND DELIVERY LINES

This option is basically the same as that in Option 1. The effect of burying lines below the ground level does not affect final suction conditions since the head gained in going below ground level offsets the additional lift at the injector end. It is necessary to make certain on initial startup and priming of the system that all air is removed from the supply lines and the various components.

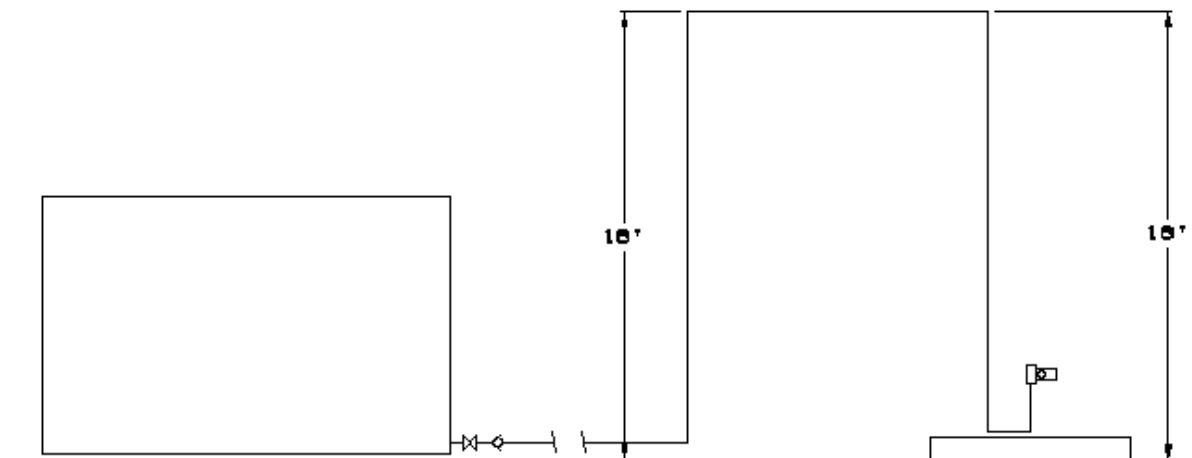

OPTION 3 - ABOVE GROUND TANK WITH HIGH CLEARANCE OBSTACLE

This application for a non-pressurized additive system is difficult to achieve in the real world because fittings and check valves notoriously leak. . This is not recommended. If equipment is installed in this manner it will void the factory warranty.

Hammonds Model 600ER-1M-1P2-1P2 Injection System Manual



OPTION 4 - BELOW GROUND TANK, BELOW GROUND LINES

This is the most difficult application for a non-pressurized additive supply. In this case, the pump must overcome a negative lift equal to the total distance between the bottom of the tank and the injector above ground.

This is not recommended because fittings and check valves leak. If equipment is installed in this manner it will void the factory warranty.

PREPARATION FOR CALIBRATION AND STARTUP

Before Attempting To Start The System Or Make Calibrations, Please Read The Following Information Carefully.

During startup and calibration, you will be bleeding the system of air, collecting samples of additive during the calibration and checking for possible leaks throughout the system. Provisions should be made for collection or clean-up of spilled fluid. Attempts should be made to minimize losses during these procedures. If the additive being handled is flammable, fire safety precautions should be taken. Since the installation may also be tested at this time, extreme caution should be used in checking for leaks of the main line. If you wish to set the system up for leak-free testing and calibration with zero spillage, please consult your local distributor or the factory for help in doing so. Hammonds is glad to suggest any necessary parts and procedure for "zero spill" startup and calibration.

A WORD ABOUT ADDITIVES

Most additives being used in fuels today have at least some degree of toxicity. Many are very dangerous. Extreme caution should be taken in handling additives. Remember, the additive is placed under pressure when being injected into the line, and when collecting samples during calibration, some spillage may occur. Be careful, wear protective clothing including eye protection. Be sure you have facilities to wash off any additive that may come in contact with your skin. Read all additive manufacturers safety precautions and Material Safety Data Sheets, following them to the letter.

Hammonds Model 600ER-1M-1P2-1P2 Injection System Manual

HERE IS WHAT IS NEEDED:

Appropriate safety protection equipment.
Eye protection in the form of safety goggles.
An assortment of wrenches that fit the various fittings on the system. Note: two (2) 10" crescent wrenches will normally take care of any adjustments to fittings you may have to make. One to hold the fitting, and one to hold the adjacent fitting.
A marked graduated glass bottle that is marked in either cc's or ounces. (At least 16 oz.)
A stop watch.

A means of determining the flow rate of the main system.

A small pocket calculator is helpful.

A clipboard is helpful with pad of paper.

AT LEAST ONE, AND PREFERABLY TWO HELPERS

A large container or catch basin to collect the output of the pump while you are not actually calibrating the system.

REMEMBER: Any plumbing system varies with temperature and fluid being pumped. The system also changes as parts of the pump wear.

CALIBRATION AND STARTUP

IF YOUR INJECTOR SYSTEM IS EQUIPED WITH CALIBRATION GAUGES, FOLLOW THE INSTRUCTIONS FOR THEIR USE IN THE BACK OF THIS MANUAL.

PROPER ADDITIVE INJECTION RATIOS

Although volumetric calibration at atmospheric pressure will bring you within an acceptable range of additive injection, the only true evaluation for proper ratio is the ASTM D-5006 evaluation for fuel system ice inhibitor (FSII). Do not depend on volumetric calibration to ensure on-spec performance because line pressures can vary and additive injector parts wear over time. Contact Hammonds Fuel Additives, Inc. for supply of quality fuel system ice inhibitor and fuel testing procedures.

Please Follow These Steps In Their Given Order. Read Them Over Carefully Before Starting, Then Follow Them To The Letter. If There is Any Part Of The Procedure That Is Not Clear, Consult Your Local Distributor Or The Factory Directly.

1. Make certain the additive tank is full of the proper additive.

2. Open the suction valve between the tank and the pump. This valve should be located at any point between the additive tank and the injector.

3. All systems are calibrated at the factory to customer specified requirements. So if adjustments are required, they should only be minor. If this is the case, go directly to step 6.

4. FOR HAMMONDS PUMPS ONLY: If you are starting from scratch in the calibration and adjustment, loosen the stroke adjustment locking screws located on the bottom of the pump body directly under the stroke adjustment knob. This will allow the stroke adjustment to be moved. These are not the dial knobs within the circle of numbers, these are lock down screws.

5. A. FOR HAMMONDS PUMPS ONLY: Adjust the stroke adjustment knobs located on the pump body to approximately 50%. **CAUTION:** Do not turn these adjustments with excessive force. If they are difficult to adjust, simply rotate the main rotor shaft, by

Hammonds Model 600ER-1M-1P2-1P2 Injection System Manual

producing flow in main product line. Lock the stroke adjustment locking screws down firmly.

6. B. FOR SPECIAL ROTARY PUMPS:
To increase injector output, turn hand crank to next number. To decrease output, turn to higher number. **CAUTION: Only adjust variable belt drive while fluid motor is turning.**

7. Set the calibration valve (3-way valve) in the "calibrate position." This is done by making certain that the handle on the valve is positioned so that additive will exit through the short open tube.

8. Make certain all product connections going to and from the system are in their proper, locked position to ensure safe, leakproof flow of product through the fluid motor. Double check the flow direction arrows located on the fluid motor housing, and check valves before and after the pump to ensure that the system is installed properly.

9. At this point, consider the information you will have to gather during the next few steps of the calibration process.

A. What will the flow rate through the unit be?

B. What is the length of time that the calibration will cover?

C. What is the amount of additive in ounces or cc's that you will need to collect based on the duration of the calibration.

You Should Have the Answer To All Of These Questions Before Your First Trial Run.

10. Before starting the main product flow through the system, make certain everyone understands that you will run the system for, let's say, one (1) minute. Even shorter runs

are fine, especially if you are running at high flow rates.

11. Place the measured graduate under the calibration tube. Put on your eye protection.

12. At the command of the time keeper, or that person watching the flow meter, start the main product pumps.

13. Give the system a few seconds to gather momentum and flow through the fluid motor. Notice if the additive injector system is turning. The bearing on the shaft under the stroke adjustment knob cover should be spinning.

14. If the pump is being started up for the first time, it will take a few seconds to prime itself and begin discharging fluid from the calibration tube. Is your eye protection on? If not, **PUT IT ON NOW!**

15. As soon as the pump begins discharging a clear, air free stream of fluid from the calibration tube, you are ready to begin your calibration. At this point, the system is primed.

*** Hammonds recommends using the Pressure Simulating Calibration Device, an optional accessory item, to duplicate system pressure during calibration.**

16. You will now prepare to make your first actual calibration run. Empty your collected additive back into the tank, putting the bottle back under the calibration tube. Notice the setting on the main product meter, set your stop watch at zero.

17. When ready, start the system again. Stop it at the decided time interval or meter reading. Calculate the amount of product that traveled through the system. Measure the amount of additive gathered, and record the amount of elapsed time.

Hammonds Model 600ER-1M-1P2-1P2 Injection System Manual

18. It will be at this time that you will have to calculate how much additive you should have collected for the amount of fuel that the system pumped. This, of course, depends upon the ratio that is required. The following example is the easiest way of explaining the procedure without getting too complicated. It is not the only way...use it if you like.

Example condition: Amount of product pumped: 500 gallons
Ratio of additive desired: 250 PPM (Parts per million)

It is assumed that the operator will know how much product is being pumped through the system in a given length of time. If, for example, you have a meter that registers the flow in gallons, you simply record the gallons at the beginning of the timed run, and then again at the end of the run. If you run for one (1) minute, you simply subtract the beginning number on the meter from the number registered after the run. This will give you the gallons per minute (GPM). Having to make this calculation is the only reason for timing the run. You can accomplish the same result by just watching the meter and stopping the system when you have totaled the desired amount of gallons through the system. In any case, you must know the amount of product passing through the system before calibration can begin.

First, change the gallons pumped into ounces by multiplying total gallons (in our example 500) by 128 (128 oz. to a gallon). The answer is 64,000 ounces.

Second, divide by 1,000,000. The answer is .06. Since you are dealing in 1/1,000,000 (one part per million) of the total for your ratio, you must find out what 1/1,000,000 of the 500 gallons is, .06 ounces is

1/1,000,000th (one part per million) of 500 gallons.

Third, multiply the .06 x 250 (for 250 PPM ratio). The answer is 15 ounces.

So, you should collect 15 ounces of additive for every 500 gallons of fuel pumped.

These are all large, round numbers. You may, for example, only be running at 100 GPM, not 500. Use the same procedure, just change the numbers to fit your application.

No two systems will ever perform exactly the same. For this reason, the procedures given for calibration are general in nature. Obviously, it is impossible to provide a graph or table that would be absolutely accurate in every case. With that in mind, all tables and graphs should be used as general guidelines. Remember, the calculated, timed and measured output that you gather is absolute. Trust your figures and your calculations.

Hammonds Model 600ER-1M-1P2-1P2 Injection System Manual

NORMAL OPERATION

Following initial start up and calibration, the system requires very little attention other than making certain that additive tank levels are maintained. Operators will quickly become accustomed to the performance of the system by observing the Suction Sight Flow Indicators. On-spec injection will cause a certain response in the indicators, and with some practice, operators will be able to observe the system at a glance. *This does not mean that system calibration should not be periodically checked!* However, during a

busy workload, these visual checks will provide assurance to the operator that the system is functioning.

Assuming the system remains set up and operating at least intermittently, calibration is required perhaps every 1 – 3 months. Good record keeping of additive inventory and use levels compared to fuel handled can give a good indication that additive is on specification. Test such as the refractometer for FSII content should be the final test to verify additive injection ratios.

SAMPLE ADDITIVE CHART

GALLONS	135 PPM	270 PPM	1000 PPM
100	1.7 OZ.	3.4 OZ.	12.8 OZ.
200	3.4 OZ.	6.9 OZ.	25.6 OZ.
400	6.9 OZ.	13.8 OZ.	51.2 OZ.
500	8.6 OZ.	17.2 OZ.	64.0 OZ.
700	12.0 OZ.	24.0 OZ.	89.6 OZ.
1000	17.2 OZ.	34.5 OZ.	128.0 OZ.

TROUBLESHOOTING THE SYSTEM

The following conditions are given as a means of troubleshooting the system. Each condition lists a number of possible causes. In most cases, trouble can be solved by the use of this section. Please read it carefully before attempting repairs or making changes in the system.

FLUID MOTOR IS NOT TURNING

- A. Insufficient flow to turn the motor. A minimum flow of about 20 GPM is needed to start the system.
- B. A rag or some other object is jammed in the line preventing the fluid motor from turning.

- C. A diverter valve is blocked downstream of the system, blocking the fuel flow through the system.
- D. A valve is closed upstream of the fluid motor starving the product flow.
- E. If the unit has been recently serviced internally, or it is new, the rotor might be installed backwards. Consult the factory before disassembly.

Hammonds Model 600ER-1M-1P2-1P2 Injection System Manual

INJECTOR IS TURNING AND PUMP IS RUNNING, BUT WITH NO OUTPUT

A. Pump is air-locked. In some cases where there is a very long line running from the injector head and the point of injection into the system, there is sufficient air volume to cause the pump to act as a compressor. It is not able to open the valves throughout the system and therefore, cannot pull a suction of fluid to the pump. Loosen the connection at the injection point check valve and allow it to remain open until the pump begins pumping. This is rare, but can happen in some cases of unusual installations.

B. One or more of the suction or discharge check valves are not working. While the pump is running, tap on the side of the valves, one at a time. This will generally jar them loose. The poppets and seals are very small, and will sometimes become stuck. After the valve is loosened and has a supply of fluid, usually it will not stick again.

C. The pump is not getting additive. Check the valve between the pump and the tank. Check all connections in the line between the pump and the tank.

D. The vent on the tank is not open causing the pump to pull a vacuum. Open the vent. Check to see if the cap has been removed from the dryer cartridge, if so equipped.

E. The pump stroke is set at zero. Check to see if the locking screws have been left loose, allowing the adjustment knobs to rotate to zero percent (0%) of stroke.

F. The additive tank is empty...don't laugh, it happens.

THE INJECTOR IS OPERATING BUT WITH REDUCED OUTPUT

A. Leaking suction line or trash in discharge check valve.

B. Air leak in suction side of system.

C. Defective tubing or piping on suction side.

D. Leaks in threaded connections - suction side.

E. If so equipped, a relief valve on injector may be bleeding part of the output back to suction. Relief valve may not be working, or retaining nut may have vibrated loose causing valve to fail entirely, bleeding output back to suction.

F. Injector diaphragm may be pulled out in back causing the injector to pump in forward portion of stroke only. This will not create a visible leak but will reduce output by 50%. It usually happens after many hours of operation.

G. Fluid motor vanes are badly worn. This would only be probable after a very high number of hours of operation.

Hammonds Model 600ER-1M-1P2-1P2 Injection System Manual

PREVENTIVE MAINTENANCE

1. Make certain to use only clean, fresh additive that has been stored in a sealed container. Most additives are moisture sensitive. Some will form heavy crystals if allowed to accumulate moisture. These crystals will stop the pump in very short order, if not cause calibration to be changed due to clogging of the valves and other parts.
2. Check the additive filter screen at least every six months. More often if there is an indication of possible contamination.
3. Check the system for leaks at every use. This is an extremely important safety procedure, since some additives are flammable, caustic and corrosive.
4. Check for leaks from the seal that is located at the exit point of the injector output shaft in the side plate housing. This should be done at each operation. Leakage at this point usually indicates that the mechanical seal inside the rotor housing is leaking. A leak here will be fuel, and is not only dangerous from a fire standpoint, but will quickly ruin the bearings on the rotor shaft, since all lubricant will be washed away.
5. Check the fittings for leakage around the suction strainer or sight flow indicator, if one is used on the pump. Check this fitting each time the filter is changed or cleaned. Make certain there are no leaks in the suction line. A very small leak will either change the operation of the pump or prevent it from operating all together.

6. Visually check around the pump head and make certain there is no leaking of additive around the fluid ends. If there is, check the tightness of the head bolts. (40 inch pounds each)
7. Check the grease around the eccentric drive bearing in the pump every 6 months. Use a good quality white lithium spray lubricant.
8. It is recommended that the injector diaphragm be changed at least every 12 months. Every 6 months under extreme operating conditions. Doing so will prevent unexpected failures and unscheduled downtime.

Hammonds injectors are very dependable. If installed properly and sized appropriately to the application, they require very little maintenance. Remember, keep the additive clean, and the suction strainer clean. If you have problems with the pump working, it is usually in the suction side of the system (between the injection pump and the additive tank). Suction lines and fittings are notorious for leaking just enough to prevent the system from working. Always check to ensure optimum suction conditions should problems occur.

Remember, a leak in the suction allows air from the outside to be introduced into the system. It does not always mean a visible leak of additive. If the pump loses its prime or output is erratic, chances are good that there are problems in the suction side. Otherwise, if it is working...leave it alone!!!!

Hammonds Model 600ER-1M-1P2-1P2 Injection System Manual

PREVENTATIVE MAINTENANCE SCHEDULE

NOTE: It is important to read the previous pages on preventative maintenance. These intervals are general, and may vary according to individual applications and severity of service.

SERVICE FUNCTION	0-4 HRS DAILY	5-8 HRS DAILY	8+HRS DAILY
Check pump gear oil level (if equipped with a worm gear reducer)	Monthly	Monthly	Monthly
Check additive filter screen	Monthly	Monthly	Monthly
Check system for additive/fuel leaks	Daily	Daily	Daily
Inspect diaphragms/plunger seals	12 Months	6 Months	3 Months
Replace diaphragms/plunger seals	12 Months	As needed	As needed
Check eccentric bearing grease	6 Months	3 Months	Monthly
Check stroke adjustment parts for looseness	Monthly	Monthly	Monthly
Replace stroke adjustment parts	24 Months	As needed	As needed
Disassemble and inspect turbine housing and internal parts	24 Months	12 Months	8 Months
Grease bearings	12 Months	6 Months	3 Months

DESICCANT DRYER

Your Hammonds additive system may include either a custom additive tank or one of several Sight Flow Indicators. Both custom tanks and the 5-SF and 55-SF Sight Flow Indicator come equipped with a desiccant dryer cartridge. These units come in several different sizes.

Most systems come equipped with the standard 3/4" cartridge. This unit is attached to the tank or Sight Flow Indicator via a short length of black rubber hose. The cartridge has a housing constructed of a clear poly material and is filled with a blue colored desiccant crystal. All these units are shipped from the factory with a small yellow cap on the unattached end of the cartridge.

Some systems may come equipped with a large canister measuring approximately 2" diameter and 10" in length. These units perform the same function, just on a larger scale. Due to

their greater capacity, they last longer between service. These units are sealed from the factory by a small, plastic plug which is located either on the bottom or one side of the canister.

The purpose of all desiccant dryers is simply to remove moisture from the air as the system breathes. All tanks or portable sources of additive supply must be vented to atmosphere in order for the injector to operate. If moisture in this venting air is not removed, some additives are either ruined or seriously damaged. Fuel System Icing Inhibitor (FSII), for example, is designed to seek out water in a fluid. So, when enough moisture is absorbed into the container, the FSII is diluted and at some point will be ruined. Biobor® JF, an anti-fungal material, will form crystals in the presence of moisture and not only perform unsatisfactorily as an additive, but will stop up pumps and lines as well.

Hammonds Model 600ER-1M-1P2-1P2 Injection System Manual

The following instructions apply to all desiccant cartridges:

A. Remove the yellow cap or plug when the system is placed into service.

B. Observe the color of the desiccant. The original color is blue. As moisture is absorbed, the color will change to pink. When the cartridge is completely pink, it should either have its contents removed, dried and replaced, or the entire unit replaced.

C. NOTE: The contents can be removed from plastic container, placed on a pan and baked at 400°F in a conventional oven until the moisture has been removed. When the color blue returns, the cooled material may be reinstalled into plastic containers and is again ready for service.

D. Color change and cartridge life is totally dependent on humidity. The more moist the air, the shorter the life. Keeping it dry is especially important if additive is not consumed rapidly. Check daily and service as needed.

Hammonds Model 600ER-1M-1P2-1P2 Injection System Manual

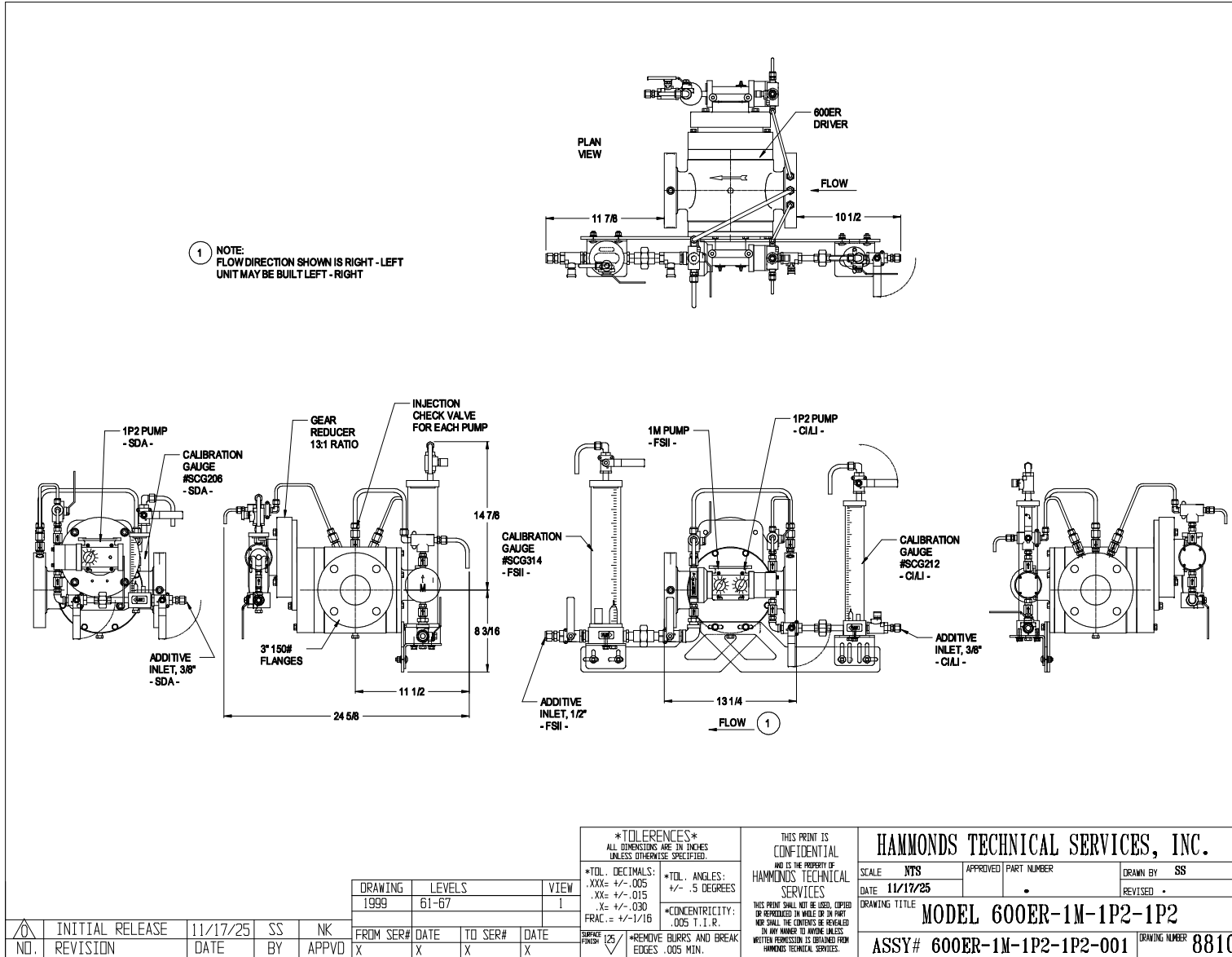

Hammonds Model 600ER-1M-1P2-1P2 Injection System Manual

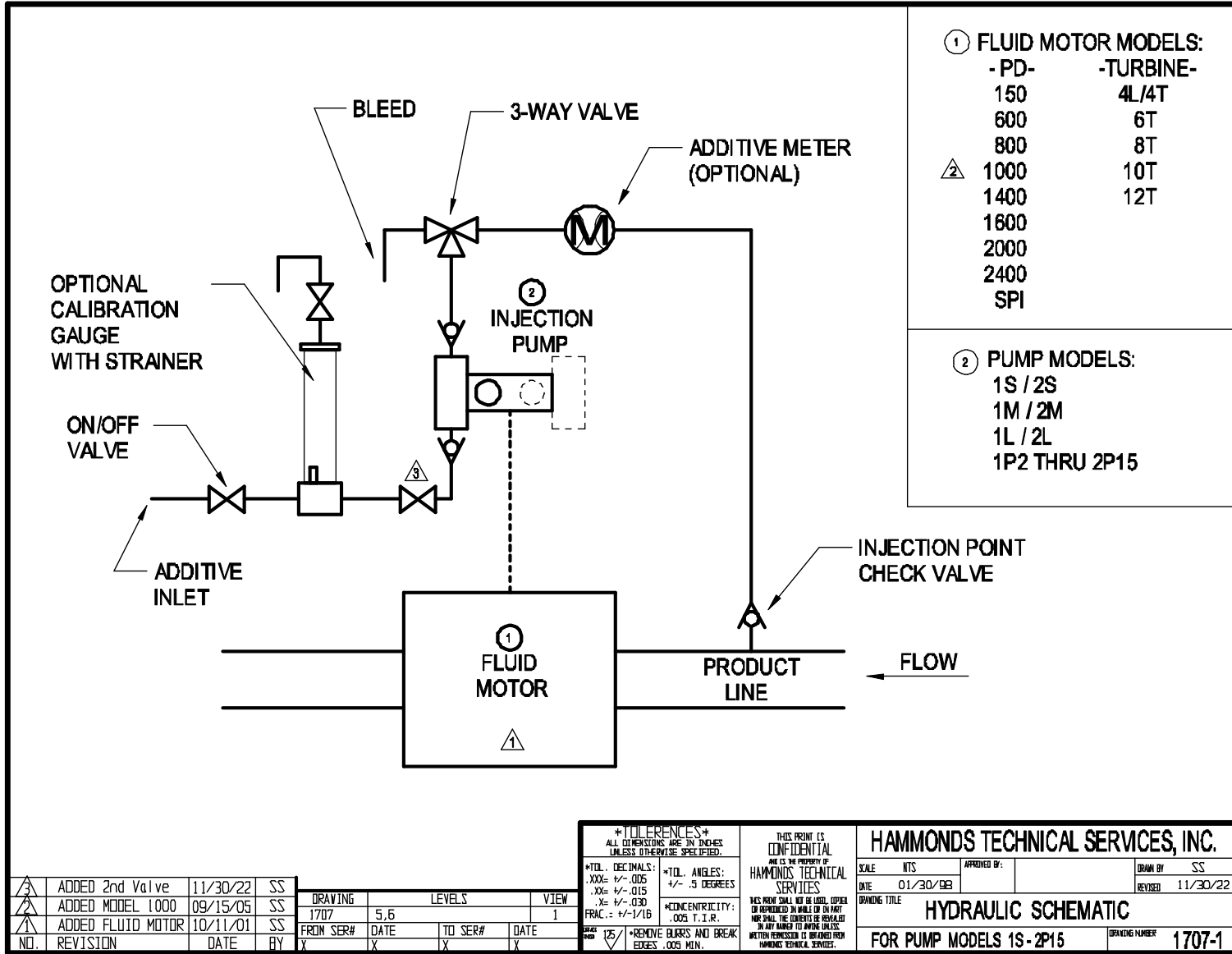

Hammonds Model 600ER-1M-1P2-1P2 Injection System Manual

ITEM	PART NO.	QTY.	DESCRIPTION
1	101045	1	SNAP RING
2	881157	1	PUMP DRIVE BEARING
3	881629	1	SPACER
4	881120	3	BEARING
5	881121	2	SNAP RING
6	881119	4	SNAP RING
7	882011	1	PUMP SIDE PLATE
8	212049	1	SHAFT, 600ER
9	212002	2	KEY, 3/16" SQ. x 1"
10	141006	2	MECHANICAL SEAL
11	882012	2	WEAR RING
12	212097	6	VANE, TEFLON
13	212006	1	ROTOR
14	881910	2	O RING, VITON
15	212250-1	1	HOUSING, ALUM, 3" 150#
16	151005	1	PIPE PLUG, 1/4"
17	881124	16	LOCKWASHER, 5/16", PLTD
18	881417	16	LOCKWASHER, 5/16", SS
19	881125	8	BOLT, 5/16" x 1", PLTD
20	881422	8	BOLT, 5/16" x 1", SS
21	212015	1	SIDE PLATE
22	212016	1	SPACER, SEAL
23	881269	8	BOLT, 5/16" x 2 1/4", PLTD
24	885233	8	BOLT, 5/16" x 2 1/4", SS
25	190013	1	GEAR, 14 TOOTH (8.5:1)
26	190009	1	GEAR, 11 TOOTH (13:1)
27			(OPTIONAL RATIO)
28	255054	1	3/32" ROLL PIN
29	271898	5	ALLEN PIPE PLUG, 1/4"

DRAWING		LEVELS		VIEW	
600DRVR		109, 140, 149, 151,		1	
		154-156, 168, 255			
FROM SER#	DATE	TO SER#	DATE		
X	X	X	X		

TOLERANCES			
ALL DIMENSIONS ARE IN INCHES UNLESS OTHERWISE SPECIFIED.			
*TOL. DECIMALS:	.XXX= +/- .005	*TOL. ANGLES:	+/- .5 DEGREES
	.XX= +/- .015		
	.X= +/- .030	*CONCENTRICITY:	.005 T. I. R.
	FRAC. = +/- 1/16		
*REMOVE BURRS AND BREAK EDGES .005 MIN.			

THIS PRINT IS CONFIDENTIAL AND IS THE PROPERTY OF HAMMONDS TECHNICAL SERVICES			
SCALE: NTS		APPROVED PART NUMBER	
DATE: 11/26/03		DRAWN BY: SS	
		REVISED: 03/18/24	
DRAWING TITLE: MODEL 600ER DRIVER			
8.5:1 & 13:1 REDUCER			DRAWING NUMBER: 4781

Hammonds Model 600ER-1M-1P2-1P2 Injection System Manual

ITEM	PART NO.	QTY.	DESCRIPTION
1	212047	1	ADAPTER PLATE, 13:1
2	212046	1	GEAR HOUSING, 13:1
3	881673	1	SET SCREW
4	150011-02	1	KEY, 1/8" SQ. x 5/8"
5	881711	8	3/8" LOCKWASHER, SS
6	885009	2	3/8-16 x 2" HEX BOLT, SS
6A	883379	2	3/8-16 x 2-1/4" HEX BOLT, SS
7	881120	3	BEARING
8	881119	3	SNAP RING
9			
10	881157	1	BEARING, H.D. DRIVE
11	101045	1	SNAP RING
12	212048	1	OUTPUT SHAFT
13	881024	1	SEAL
14	190010	1	GEAR, 144 TOOTH
15	190009	1	PINION GEAR, 11 TOOTH
16	881709	4	3/8-16 x 1" HEX BOLT, SS
17	881521	1	GREASE FITTING

HAMMONDS MODEL 600ER DRIVER SHOWN

DRAWING		LEVELS		VIEW	
1810		21-23		1	

NO.	REVISION	DATE	BY	APPVD	FROM SER#	DATE	TO SER#	DATE
1	WAS PLT'D BOLTS	03/19/24	SS	JH				
2	WAS 2 QTY.	02/16/07	SS	CH				
					X	X	X	X

TOLERANCES
ALL DIMENSIONS ARE IN INCHES UNLESS OTHERWISE SPECIFIED.

*TOL. DECIMALS:
XXX= +/- .005
.XX= +/- .015
.X= +/- .030
FRAC.= +/- 1/16

*TOL. ANGLES:
+/- .5 DEGREES

*CONCENTRICITY:
.005 T.I.R.

*REMOVE BURRS AND BREAK EDGES .005 MIN.

THIS PRINT IS CONFIDENTIAL AND IS THE PROPERTY OF HAMMONDS TECHNICAL SERVICES

THIS PRINT SHALL NOT BE USED, COPIED OR REPRODUCED BY WHOLE OR IN PART FOR SHALL THE CONTENTS BE RELEASED IN ANY MANNER TO ANYONE UNLESS WRITTEN PERMISSION IS OBTAINED FROM HAMMONDS TECHNICAL SERVICES.

HAMMONDS TECHNICAL SERVICES, INC.

SCALE: NTS APPROVED PART NUMBER: .

DATE: 11/28/03 REVISED: 03/18/24

DRAWING TITLE: **HAMMONDS 13:1 GEAR REDUCER**

MAT'L: DRAWING NUMBER: **4782**

Hammonds Model 600ER-1M-1P2-1P2 Injection System Manual

ITEM	PART NO.	QTY.	DESCRIPTION
1	101014	1	POWER FRAME
2	221001	1	M DIAPHRAGM, STANDARD
★ 2	221008	1	M DIAPHRAGM, VITON, (OPTION)
3	222002	1	FLUID END, M
4	882949	8	LOCK WASHER, #10 INT. TOOTH
5	101037	4	SCREW, 10-32 x 1 1/2"
6	101842	1	CROSSHEAD GUIDE
7	101007	2	RETURN SPRING
8	101006	1	CROSSHEAD
9	101152	2	SLIDE BEARING
10	101005	1	STROKE ADJUSTMENT CAM
11	101003	1	CAM GUIDE
12	101001	1	STROKE ADJUSTMENT KNOB
13	101002	1	POWER FRAME COVER
14	101004-BW	1	LOCK SCREW
15	101009	4	SCREW, 8-32 x 3/8"
16	881086	4	LOCKWASHER, #6
17	101010	4	SCREW, 6-32 x 3/8"
18	881089	4	SCREW, 10-32 x 3/4"
18A	881660	4	SCREW, 10-32 x 2 1/4" (OPT)
19	104311	2	CHECK VALVE, 1 PSI, AFLAS
	104310	2	CHECK VALVE, 1 PSI, VITON (OPT)
	104318	2	CHECK VALVE, 1 PSI, KALREZ (OPT)
20	222001	1	ADAPTER RING, M
21	222003	1	BACK UP RING
22	881170	4	SCREW, #10 x 5/8" BUTTON HD.
23	101038	4	LOCKWASHER, #10 H.C.
24	104315	1	CHECK VALVE, 5 PSI, AFLAS (STD)
	104314	1	CHECK VALVE, 5 PSI, VITON (OPT)
	104319	1	CHECK VALVE, 5 PSI, KALREZ (OPT)
25	101088	1	3/8 x 1/4 FNPT TUBE ADAPT.

NO	REVISION	DATE	BY	APPVD
△	NEW LOCK SCREW	11/01/24	SS	JH
△	NEW VALVES	04/25/23	SS	JH
△	WAS #101933	03/15/04	SS	JH
△	SOFT SEAT CHK VLV	09/03/02	SS	X
△	WAS #101008	08/99	SS	X

DRAWING	LEVELS	VIEW
INJECTOR	10, 12, 14, 16, 18, 20, 24	1
	28, 30, 39-41, 67-76, 129	

FROM SER#	DATE	TO SER#	DATE
X	X	X	X

TOLERANCES
ALL DIMENSIONS ARE IN INCHES UNLESS OTHERWISE SPECIFIED.

+TOL. DECIMALS: .XXX= +/- .005 .XX= +/- .015 .X= +/- .030 FRAC.= +/- 1/16	+TOL. ANGLES: +/- .5 DEGREES -CONCENTRICITY: .005 T. I. R.
---	---

REMOVE BURRS AND BREAK EDGES .005 MIN.

THIS PRINT IS CONFIDENTIAL AND IS THE PROPERTY OF HAMMONDS TECHNICAL SERVICES

THIS PRINT SHALL NOT BE USED, COPIED OR REPRODUCED IN WHOLE OR IN PART AND SHALL BE RETURNED TO THE COMPANY IN ANY MANNER TO AVOID UNLESS WRITTEN PERMISSION IS OBTAINED FROM HAMMONDS TECHNICAL SERVICES.

HAMMONDS TECHNICAL SERVICES, INC.			
SCALE: NTS	APPROVED PART NUMBER:	DRAWN BY: SS	
DATE: 10/01/87		REVISED: 11/01/24	
DRAWING TITLE: HAMMONDS 1M PUMP ASSEMBLY		DRAWING NUMBER: 0593	

Hammonds Model 600ER-1M-1P2-1P2 Injection System Manual

1

① REMOVE LOCK SCREW
② REMOVE DIAL KNOB
③ REMOVE PLASTIC COVER
④ REMOVE SCREWS HOLDING FLUID END. REMOVE FLUID END.

2

CROSSHEAD
ADAPTER RING
⑤ PRESS DIAL KNOB BACK ON AND ROTATE COUNTER CLOCKWISE UNTIL DIAPHRAGM HAS CLEARED SURFACE OF ADAPTER RING AND CROSSHEAD HAS CLEARED DRIVE BEARING.
⑥ REMOVE SNAP RING
⑦ SLIDE DRIVE BEARING OFF
⑧ UNSCREW OLD DIAPHRAGM

3

⑨ WITH DIAL SET IN SAME COUNTER CLOCKWISE (FULL OUT) POSITION, INSTALL NEW DIAPHRAGM, THREADING INTO CROSSHEAD ALL THE WAY. DO NOT OVER-TIGHTEN!

*** WARNING... FAILURE TO TORQUE SCREWS PROPERLY TO 40 IN. LBS. WILL REDUCE PUMP HEAD PERFORMANCE, RESULTING IN INSUFFICIENT INJECTION RATIO.**

⑪ REINSTALL SCREWS, TAKING EACH ONE DOWN BY HAND UNTIL IT STOPS. TIGHTEN SCREWS TO 40 IN.LBS. * IN THE ORDER SHOWN BELOW. TORQUE EACH SCREW IN THE PATTERN, THEN REPEAT THE TORQUE SEQUENCE ONLY ONCE!

WARNING!
FAILURE TO FOLLOW THIS PROCEDURE WILL RESULT IN DIAPHRAGM DEFORMATION AND PREMATURE FAILURE.

⑩ ROTATE DIAL FULLY IN OPPOSITE DIRECTION (CLOCKWISE) BRINGING DIAPHRAGM AT REST AGAINST ADAPTER RING.

4

⑫ ROTATE DIAL COUNTER CLOCKWISE ENOUGH TO INSTALL DRIVE BEARING. INSTALL SNAP RING.

⑬ REMOVE DIAL KNOB. REINSTALL PLASTIC COVER. REINSTALL DIAL KNOB AND POSITION IT ON ORIGINAL % SETTING. INSTALL LOCK SCREW, LOCK DIAL IN PLACE.

NOTE: AFTER THIS PROCEDURE IS COMPLETE, YOU MUST RECALIBRATE THE INJECTOR TO YOUR SPECIFICATIONS.

HAMMONDS TECHNICAL SERVICES, INC.

SCALE	NTS	APPROVED BY:	DRAWN BY	S.S.
DATE	2/1/82		REVISED	4/10/82
DRAWING TITLE				
"M" DIAPHRAGM REPLACEMENT				
				DRAWING NUMBER
				1460

FOR TECHNICAL ASSISTANCE CALL
HAMMONDS TECHNICAL SERVICES
(800) 582-4224

Hammonds Model 600ER-1M-1P2-1P2 Injection System Manual

ITEM	PART NO.	QTY.	DESCRIPTION
1	101014	1	POWER FRAME
2	102266	1	PLUNGER, P2
3	102267	1	FLUID END, P2
4	882949	8	LOCK WASHER, #10 INT. TOOTH
5	881780	4	SCREW, 10-32 x 2 3/4"
6	101842	1	CROSSHEAD GUIDE
7	101007	2	RETURN SPRING
8	101006	1	CROSSHEAD
9	101152	2	SLIDE BEARING
10	101005	1	STROKE ADJUSTMENT CAM
11	101003	1	CAM GUIDE
12	101001	1	STROKE ADJUSTMENT KNOB
13	101002	1	POWER FRAME COVER
14	101004-BW	1	LOCK SCREW
15	101009	4	SCREW, 8-32 x 3/8"
16	881086	4	LOCKWASHER, #6
17	101010	4	SCREW, 6-32 x 3/8"
18	881089	4	SCREW, 10-32 x 3/4"
18A	881660	4	SCREW, 10-32 x 2 1/4" (OPTION)
19	104321	2	CHECK VALVE, 1/8", 1 PSI, AFLAS
	104320	2	CHECK VALVE, 1/8", 1 PSI, VITON (OPT)
20	102269	1	O-RING, AFLAS
20A	102270	1	O-RING, VITON (OPTION)
21	102268	1	SEAL HOUSING, P2
22	881024	1	SEAL, LIP
24	104315	1	CHECK VALVE, 1/4", 5 PSI, AFLAS
	104314	1	CHECK VALVE, 1/4", 5 PSI, VITON (OPT)
25	101058	1	1/4 x 1/4 FNPT TUBE ADAPT

NO.	REVISION	DATE	BY	APPVD	X	FROM SER#	DATE	TO SER#	DATE	X	X	X
△	NEW LOCK SCREW	11/01/24	SS	JH								
△	ADDED VITON CK VLV	09/23/24	SS	JH								
△	WAS 102783 & 882911	04/05/23	SS	JH								
△	WAS #102463	02/20/08	SS	X								
△	WAS #101933	03/15/04	SS	X								

TOLERANCES
ALL DIMENSIONS ARE IN INCHES UNLESS OTHERWISE SPECIFIED.

*TOL. DECIMALS:
.XXX= +/- .005
.XX= +/- .015
.X= +/- .030
FRAC.= +/- 1/16

*TOL. ANGLES:
+/- .5 DEGREES

*CONCENTRICITY:
.005 T.I.R.

SURFACE FINISH: 125
*REMOVE BURRS AND BREAK EDGES .005 MIN.

THIS PRINT IS CONFIDENTIAL AND IS THE PROPERTY OF HAMMONDS TECHNICAL SERVICES. THIS PRINT SHALL NOT BE USED, COPIED OR REPRODUCED IN WHOLE OR IN PART. YOU SHALL BE RESPONSIBLE IN ANY MANNER TO AVOID UNLESS WRITTEN PERMISSION IS OBTAINED FROM HAMMONDS TECHNICAL SERVICES.

HAMMONDS TECHNICAL SERVICES, INC.			
SCALE: NTS	APPROVED PART NUMBER	DRAWN BY: SS	
DATE: 06/20/95		REVISED: 11/01/24	
DRAWING TITLE: HAMMONDS 1P2 PUMP		DRAWING NUMBER: 4567	

Hammonds Model 600ER-1M-1P2-1P2 Injection System Manual

PARTS INCLUDED IN KITS ARE IDENTIFIED WITH →
NOTE: OPTIONAL O-RING ELASTOMERS ARE AVAILABLE.

INSTALL CAP HAND-TIGHT... DO NOT OVER-TIGHTEN!

IMPORTANT!
NOTE DIRECTION OF FLOW
VALVE DETAIL SCALE: 2X

ITEM	PART NO.	QTY.	DESCRIPTION
1	152080	1	BODY, LARGE SIGHT FLOW
2	152025	1	FILTER ELEMENT
3	151014	1	GAUGE GLASS
4	151013	2	GASKET, VITON
	151010	2	GASKET, NEOPRENE, OPT.
	151025	2	GASKET, BUNA-N, OPT.
5	152042	1	CAP
6	101070	1	NIPPLE, 1/4" x 1 1/2"
7	881139-05	1	VENT TUBE, 3/8"
8	101230	1	ON/OFF VALVE, 1/4"
9	101068	1	ELBOW TUBE FITTING
10	881899	1	GUARD, GAUGE GLASS
11	882562	1	STRAP, VINYL COATED (OPT)
12	881292	1	1/4-20 x 3/4" SOC HD CAP (OPT)
13	103028	1	1/4" FLAT WASHER SS (OPT)
14	881881	1	1/4-20 LOCK NUT SS (OPT)
15	151005	1	PIPE PLUG, 1/4"
16	104315	1	1/4" CH VLV, 5 PSI, AFLAS (OPT)
	104314	1	1/4" CH VLV, 5 PSI, VITON (OPT)
17	881422	2	5/16-18 x 1" HX HD BOLT, SS
18	881417	2	5/16" LOCK WASHER, SS
19	104042	2	5/16" FLAT WASHER, SS

NOTE: ADAPTER FITTINGS VARY PER APPLICATION... SEE YOUR ASSEMBLY ILLUSTRATION

FLUSH VALVE ...SEE DETAIL

NEW CHECK VALVES	04/05/23	SS	JH			
WAS 102735 VALVE	07/13/21	SS	JH			
ADDED KIT INFO	04/30/18	SS	X			
ADDED FLUSH VALVE	05/23/14	SS	X			
WAS 881139	03/07/14	SS	X			
ADDED PLUG	03/24/10	SS	X			
ADDED PARTS	06/2008	SS	X			
NO.	REVISION	DATE	BY	APPVD	FROM SER#	DATE
					X	X

DRAWING			LEVELS			VIEW
2395			1-3			1
FROM SER#	DATE	TO SER#	DATE	FROM SER#	DATE	TO SER#
X	X	X	X	X	X	X

TOLERANCES
ALL DIMENSIONS ARE IN INCHES UNLESS OTHERWISE SPECIFIED.

*TOL. DECIMALS:
.XXX= +/- .005
.XX= +/- .015
.X= +/- .030
FRAC.= +/- 1/16

*TOL. ANGLES:
+/- .5 DEGREES

*CONCENTRICITY:
.005 T. I. R.

*REMOVE BURRS AND BREAK EDGES .005 MIN.

THIS PRINT IS CONFIDENTIAL AND IS THE PROPERTY OF HAMMONDS TECHNICAL SERVICES

THIS PRINT SHALL NOT BE REPRODUCED OR COPIED OR REPRODUCED IN WHOLE OR IN PART NOR SHALL THE CONTENTS BE REVEALED IN ANY MANNER TO WHOMEVER WITHOUT WRITTEN PERMISSION IS OBTAINED FROM HAMMONDS TECHNICAL SERVICES.

HAMMONDS TECHNICAL SERVICES, INC.

SCALE: NTS APPROVED: PART NUMBER: SCG314 DRAWN BY: SS

DATE: 07/20/93 REVISED: 04/05/23

DRAWING TITLE: **SUCTION CALIBRATION GAUGE**

MAT'L: DRAWING NUMBER: 2395

Hammonds Model 600ER-1M-1P2-1P2 Injection System Manual

**INSTALL CAP HAND-TIGHT...
DO NOT OVER-TIGHTEN!**

ITEM	PART NO.	QTY.	DESCRIPTION
2	1	152075	1 BODY, STD. SIGHT FLOW
2	2	152002	1 FILTER ELEMENT
3	3	151015	1 GAUGE GLASS
4	* 4	151002	2 GASKET, BUNA
4	* 4	151007	2 GASKET, VITON (OPT)
4	* 4	151023	2 GASKET, EPDM (OPT)
4	* 4	151026	2 GASKET, KALREZ (OPT)
4	* 4	151020	2 GASKET, AFLAS (OPT)
4	* 4	151036	2 GASKET, TEF ENCAPSUL (OPT)
4	* 4	151000-MZ	2 GASKET, MARKEZ (OPT)
5	5	151005	1 PLUG
6	6	152079	1 CAP ASSEMBLY
7	7	101070	1 NIPPLE, 1/4" x 1 1/2"
8	8	101059-04	1 VENT TUBE, 1/4"
8	881139-05	1 VENT TUBE, 3/8"...(OPT)	
9	9	101230	1 ON/OFF VALVE, STD. 1/4"
10	10	101095	1 TUBE ADAPTER, 1/4"
10	101068	1 TUBE ADAPTER, 3/8"...(OPT)	
11	11	881950	1 GUARD, GAUGE GLASS
12	12	882562	1 STRAP, VINYL COATED (OPT)
13	13	881292	1 1/4-20 x 3/4" SOC HD CAP (OPT)
14	14	103028	1 1/4" FLAT WASHER SS (OPT)
15	15	881881	1 1/4-20 LOCK NUT SS (OPT)
16	16	881422	2 5/16-18 x 1" HX HD BOLT, SS
17	17	881417	2 5/16" LOCK WASHER, SS
18	18	104042	2 5/16" FLAT WASHER, SS

NO.	REVISION	DATE	BY
△	OPTIONAL VENTS	06/13/23	SS
△	ADDED MARKEZ OPT	07/20/22	SS
△	REMOV'D 102735 VALV	07/13/21	SS
△	ADD TEF ENCAPSUL	07/13/21	SS
△	ADDED AFLAS OPT	09/04/20	SS
△	ADDED KALREZ OPT	01/18/17	SS
△	WAS #101071	02/14/14	SS
△	ADDED PARTS	06/2008	SS
△	WAS #152035	05/13/99	SS
△	WAS #152018	05/13/99	SS
△	WAS 1/8" NIPPLE	01/23/97	SS

DRAWING	LEVELS	VIEW
2489	1, 2	1
FROM SER#	DATE	TO SER#
X	X	X

TOLERANCES ALL DIMENSIONS ARE IN INCHES UNLESS OTHERWISE SPECIFIED:		THIS PRINT IS CONFIDENTIAL AND IS THE PROPERTY OF HAMMONDS TECHNICAL SERVICES	
*TOL. DECIMALS: .XXX= +/- .005 .XX= +/- .015 .X= +/- .030	*TOL. ANGLES: +/- .5 DEGREES	THIS PRINT SHALL NOT BE USED, COPIED OR REPRODUCED IN WHOLE OR IN PART AND SHALL BE RETURNED TO THE ISSUING OFFICE IN ANY MANNER TO AVOID UNLESS WRITTEN PERMISSION IS OBTAINED FROM HAMMONDS TECHNICAL SERVICES.	
*CONCENTRICITY: .005 T.I.R.			

HAMMONDS TECHNICAL SERVICES, INC.			
SCALE: NTS	APPROVED BY:	SCG212	DRAWN BY: SS
DATE: 07/20/93			REVISED: 06/13/23
DRAWING TITLE: SUCTION CALIBRATION GAUGE			
MAT' L:			DRAWING NUMBER: 2489

Hammonds Model 600ER-1M-1P2-1P2 Injection System Manual

PARTS INCLUDED IN KITS ARE IDENTIFIED WITH → NOTE: OPTIONAL O-RING ELASTOMERS ARE AVAILABLE.

INSTALL CAP HAND-TIGHT... DO NOT OVER-TIGHTEN!

NOTE: ADAPTER FITTINGS VARY PER APPLICATION... SEE YOUR ASSEMBLY ILLUSTRATION

IMPORTANT! NOTE DIRECTION OF FLOW

VALVE DETAIL SCALE: 2X

ITEM	PART NO.	QTY.	DESCRIPTION
△	1	152075	1 BODY, STD. SIGHT FLOW
△	2	152002	1 FILTER ELEMENT
→	3	151018	1 GAUGE GLASS
→	4	151002	2 GASKET, BUNA (OPT)
		151007	2 GASKET, VITON (OPT)
		151027	2 GASKET, NEOPR (OPT)
△		151026	2 GASKET, KALREZ (OPT)
△		151020	2 GASKET, AFLAS (OPT)
△		151036	2 GASKET, TEF ENCAPSULATED
	5	151005	1 PLUG
△	6	152069	1 CAP ASSEMBLY
△	7	101070	1 NIPPLE, 1/4" x 1-1/2"
△	8	101059-04	1 VENT TUBE, 1/4"
		881139-05	1 VENT TUBE, 3/8"...(OPT)
△	9	101230	1 ON/OFF VALVE, 1/4"
△	10	101095	1 TUBE ADAPTER, 1/4"
		101068	1 TUBE ADAPTER, 3/8"...(OPT)
△	11	152070	1 GUARD, GAUGE GLASS
△	12	104315	1 1/4" CH VLV, 5 PSI, AFLAS (OPT)
→		104314	1 1/4" CH VLV, 5 PSI, VITON (OPT)
		104319	1 1/4" CH VLV, 5 PSI, KALREZ (OPT)
	13	881422	2 5/16-18 x 1" HX HD BOLT, SS
	14	881417	2 5/16" LOCK WASHER, SS
	15	104042	2 5/16" FLAT WASHER, SS

△	OPTIONAL VENTS	06/13/23	SS
△	NEW CHECK VALVES	06/09/23	SS
△	REMV'D #102735 VLV	07/13/21	SS
△	ADD TEF ENCAPSUL	07/13/21	SS
△	ADDED AFLAS OPT	09/04/20	SS
△	ADDED KIT INFO	04/30/18	SS
△	ADDED FLUSH VALVE	02/15/17	SS
△	ADDED KALREZ OPT	01/18/17	SS
△	ADDED NEOPR. OPT	09/27/11	SS
△	ADDED OPT VALVE	03/04/10	SS
△	WAS #152035	05/13/99	SS
△	WAS #152018	05/13/99	SS
△	WAS 1/8" NIPPLE	01/23/97	SS
NO.	REVISION	DATE	BY

DRAWING	LEVELS	VIEW	
2489	5,6	1	
FROM SER#	DATE	TO SER#	DATE
X	X	X	X

TOLERANCES ALL DIMENSIONS ARE IN INCHES UNLESS OTHERWISE SPECIFIED.		THIS PRINT IS CONFIDENTIAL AND IS THE PROPERTY OF HAMMONDS TECHNICAL SERVICES	
*TOL. DECIMALS: .XXX= +/- .005 .XX= +/- .015 .X= +/- .030	*TOL. ANGLES: +/- .5 DEGREES	THIS PRINT SHALL NOT BE USED, COPIED OR REPRODUCED IN WHOLE OR IN PART AND SHALL BE RETURNED TO THE ORIGINAL SUPPLIER IN ANY MANNER TO AVOID UNLESS WRITTEN PERMISSION IS OBTAINED FROM HAMMONDS TECHNICAL SERVICES.	
*CONCENTRICITY: .005 T.I.R.			
REMOVE BURRS AND BREAK EDGES .005 MIN.		BRIDGE FROM 1/25	

HAMMONDS TECHNICAL SERVICES, INC.			
SCALE: NTS	APPROVED BY: SCG206	DRAWN BY: SS	
DATE: 07/20/93	REVISED: 06/13/23		
DRAWING TITLE: SUCTION CALIBRATION GAUGE			
MAT' L:			DRAWING NUMBER: 3067

Hammonds Model 600ER-1M-1P2-1P2 Injection System Manual

HAMMONDS SUCTION CALIBRATION GAUGE

CALIBRATION INSTRUCTIONS

- 1) IN ORDER TO CALIBRATE, THE PUMP MUST BE PRIMED AND PURGED OF ALL AIR. THE 3-WAY VALVE MUST BE SET TO INJECT.
- 2) WITH SUPPLY VALVE OPEN, SLOWLY OPEN VENT VALVE. THIS WILL FILL CALIBRATION GAUGE. FILL TO ZERO MARK. DO NOT OVERFILL. ONCE FULL, CLOSE VENT VALVE.
- 3) MAKE NOTE OF ADDITIVE LEVEL IN CALIBRATION GAUGE AND MAIN PRODUCT METER READING. BEGIN CALIBRATION BY FIRST CLOSING THE SUPPLY VALVE AND THEN OPENING THE VENT VALVE. START THE PRODUCT FLOW (SET FOR A SHORT TRIAL RUN).
- 4) AT THE END OF THE RUN, RECORD THE AMOUNT OF ADDITIVE THAT WAS DRAWN FROM THE CALIBRATION GAUGE. RECORD THE AMOUNT OF FUEL PUMPED. CLOSE THE VENT VALVE. OPEN THE SUPPLY VALVE.
- 5) DIVIDE THE AMOUNT OF ADDITIVE USED BY THE VOLUME OF FUEL THAT WAS PUMPED GIVING YOU PPM.
- 6) INCREASE OR DECREASE PERCENTAGE OF STROKE ON DIAPHRAGM PUMP TO OBTAIN DESIRED INJECTION RATIO.

EXAMPLE: (METRIC)
 ADDITIVE INJECTED = 500 ML
 FUEL DELIVERED = 1785 LITERS

$$\frac{500}{1785} = .280$$

$$\frac{.280}{1000} = .000280 \text{ (280 MILLIONTHS)} \\ \text{OR } 280 \text{ PPM (PARTS PER MILLION)}$$

EXAMPLE: (US)
 ADDITIVE INJECTED = 11.5 oz
 FUEL DELIVERED = 350 GALLONS

$$\frac{11.5}{350} = .0328$$

$$\frac{.0328}{128 \text{ oz/gal}} = .000256 \text{ (256 MILLIONTHS)} \\ \text{OR } 256 \text{ PPM (PARTS PER MILLION)}$$

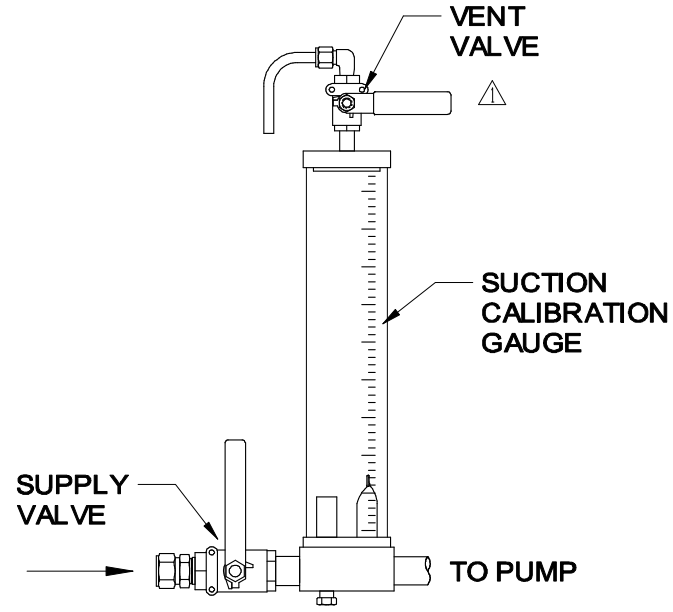

TOLERANCES ALL DIMENSIONS ARE IN INCHES UNLESS OTHERWISE SPECIFIED.		THIS PRINT IS CONFIDENTIAL AND IS THE PROPERTY OF HAMMONDS TECHNICAL SERVICES		HAMMONDS TECHNICAL SERVICES, INC.	
		*TOL. DECIMALS: .XXX± +/- .005 .XX± +/- .015 .X± +/- .030	*TOL. ANGLES: +/- .5 DEGREES *CONCENTRICITY: .005 T. I. R.	SCALE NTS DATE 04/07/93	APPROVED BY: _____ REVISED 07/13/21
*REMOVE BURRS AND BREAK EDGES .005 MIN.		THIS PRINT SHALL NOT BE USED, COPIED OR REPRODUCED IN WHOLE OR IN PART WITHOUT WRITTEN PERMISSION OF HAMMONDS TECHNICAL SERVICES.		DRAWING NUMBER 1891	

	WAS ECONOMY VALVE	07/13/21	SS	DRAWING	LEVELS	VIEW	
	INITIAL RELEASE	04/07/93	SS	1891	1,2	1	
NO.	REVISION	DATE	BY	FROM SER#	DATE	TO SER#	DATE
				X	X	X	X