

**OPERATING INSTRUCTIONS  
AND  
MAINTENANCE MANUAL  
FOR**

**HAMMONDS MODEL 6T-2M**

**FLUID POWERED  
ADDITIVE INJECTOR  
SYSTEM**

Manufactured by:



**HAMMONDS TECHNICAL SERVICES, INC.**

6807 West Little York Rd.  
Houston, Texas 77040

Phone: 281-999-2900

Fax: 281-847-1857

[www.hammondscos.com](http://www.hammondscos.com)

October 2018

# Hammonds Model 6T-2M Injection System Manual

## TABLE OF CONTENTS

Special Notice to Users	3
Installation and Preparation for Startup	3-4
Installation Considerations of Bare Units	4-5
Locating the System	6-8
Additive Supply System	8-10
Additive Tank Installation	11-13
Preparation for Calibration and Startup	13-14
Calibration and Startup	14-17
Additive Chart	17
Trouble Shooting the System	17-18
Preventive Maintenance	18-21
Preventive Maintenance Schedule	21
Desiccant Dryer Instructions	21-22

### Attachments:

- System Layout
- Hydraulic Schematic
- Drive Unit Parts
- Gear Reducer Parts
- Injector Pump Parts
- Diaphragm Replacement Instructions
- Sight Flow Indicator Parts
- Calibration Device Parts
- Calibration Device Instructions

# Hammonds Model 6T-2M Injection System Manual

## SPECIAL NOTICE TO USERS

### PLEASE READ CAREFULLY BEFORE INSTALLING EQUIPMENT

This additive injector system is designed to give consistent, dependable performance when operated and maintained according to manufacturer's recommendations. However, being a mechanical device, it is subject to failure from wear, human error and operating environments beyond the control of the system. Because of this fact, it is the responsibility of the operator to make certain that:

- A. The system is installed properly.
- B. The system is being operated properly.
- C. The system is actually running during product transfer.
- D. The system is checked after the transfer operation to make certain the proper amount of additive was injected during the operation.

The performing of these checks by the operator eliminates the possibility of product not having the proper additive ratio as required. Therefore, since the manufacturer cannot be present during each transfer operation, the responsibility for checking the performance of the system is that of the operator. Should there be any questions whatsoever, the operator should consult the factory authorized distributor, or the factory directly.

### **DO NOT TAKE CHANCES** **DO NOT GUESS**

**Be absolutely certain that the system is operating as it should. The user/operator carries the final responsibility to make certain the system is operating properly.**

## INSTALLATION AND PREPARATION FOR STARTUP

In most cases, the Hammonds fluid powered injector is shipped complete and ready to operate. The system should include appropriate fittings to suit your specific application. Flow direction is marked on additive pumps and check valves. Any and all flow restricting devices such as ON/OFF ball valves, remote panels, sight flow indicators, suction strainers or electrically controlled solenoid valves must be installed on the suction side of additive pumps.

**CAUTION: Do Not Attempt To Use This Device Without Understanding And**

**Following Proper Safety Precautions Regarding System Grounding, Fire Safety, And Special Handling For Potentially Dangerous Additives.**

Consult your Engineering Department for their specific instructions. Make certain all personnel involved with this system are thoroughly familiar with safe operating practices.

If your system has been purchased "bare," consult your equipment distributor for help in selecting hoses, fittings and

# Hammonds Model 6T-2M Injection System Manual

other related accessories. Selection of materials compatibility, location of unit within the system, effect of the unit on the system and injection point of the additive are also factors that should be discussed by factory authorized personnel. If no

factory-authorized distributor is available, consult the factory directly for assistance.

## INSTALLATION CONSIDERATIONS OF BARE UNITS

Hammonds injection systems may be installed in a wide variety of applications, systems and operating conditions. **This manual makes the assumption that the purchaser has consulted with the factory and has approval for the application and installation.** If this is not the case, listed below are a few considerations that should be reviewed before installing a unit in an existing system. Hammonds offers a wide range of performance capabilities with the same unit by matching special turbine configurations and flow conditions. Make certain the manual and the unit is specifically for your application.

### FLOW CONSIDERATIONS

The 6T high capacity units normally see flow rates of up to 1200 GPM. In these installations, flow may, depending on maximum GPM, be reduced slightly. As an example, a system performing at 600 GPM prior to installation may be reduced by as much as 30 GPM, reducing the overall system performance to 570 GPM. Obviously, this minor reduction is negligible, and, in many cases, the system pressure can be adjusted to compensate for this. In no way, will the installation of a Hammonds injector overload a product pump since any minor reduction in flow results in less horsepower demand on the system.

A reduction of 30 GPM on a 600 GPM system loading a 1000 gallon tank compartment results in an additional 5

seconds to the time required to load the compartment.

As you can see, flow rate reduction is not a concern providing the system has been properly matched to the application. If there is any doubt, consult the factory, as a standard unit not designed for the higher flows will reduce system flow considerably.

### POINT OF INJECTION OF THE ADDITIVE

Some additives may adversely affect other components in the fuel system. Seals in meters and valves, filter elements and aluminum to name a few. Unlike competitive systems that slug the additive into the product at measured intervals as high as 60 gallons, the Hammonds injector does an excellent job of mixing the additive in the product as it is being injected ahead of the turbine blades. In addition, a typical unit will inject the precise amount of additive required for every one- (1) gallon of product that flows through the system. In operation, that is a continuous flow of additive that is being mixed without gaps. This even, continuous mixing eliminates slugs of concentrated additive being dumped into the system.

# Hammonds Model 6T-2M Injection System Manual

## INSTALLATION RELATIVE TO METERS

Hammonds injectors can be installed at any point in the system. In most terminal operations, it is desirable to meter the additive. Meters, valves or strainers do not affect the system, so it can be placed wherever there is room. In aviation truck applications, it is placed up-stream of the meters, (some have two), it will precisely inject additive to the system, whether a single hose or dual hose fueling is used.

## SPACE REQUIREMENTS

The system is designed with easy services in mind. The entire turbine and pump assembly can be removed from the housing without disturbing the system piping. Ample room should be reserved in the installation for this removal, if possible. Also, the operator needs to have visual access to the controls on the pump for calibration.

## ON/OFF OPERATION

There are two methods for providing ON/OFF operation to the system. One is by using a remote panel that includes a special rotary valve connecting the additive tank and the injector appropriately, and the other (for HAMMONDS DIAPHRAGM PUMPS ONLY) is a simple, 2-position ball valve installed in the additive supply line that connects the additive storage tank and the injector. Preferably, the valve should be

located as close to the injector as possible. Turning this valve off for a short duration does not harm the unit in any way, nor does it cause the unit to lose the prime of additive. As soon as the valve is opened, the pump immediately begins injection without any loss of ratio whatsoever.

***Caution: NEVER install an on/off valve on the discharge side of any pump. Turning this valve off will block the discharge of the pump, rupturing the diaphragm or plunger seal resulting in an uncontrolled leak of additive and causing catastrophic failure to the pump.***

## PLACEMENT OF THE ELECTRIC ON/OFF SOLENOID

Some systems use an electric powered on/off solenoid for remote operation of the system. When used, the ideal location for this valve is between the injector and the Calibration Gauge or Sight Flow Indicator. The valve should be placed as close to the injector as possible. In terminal installation, it is not recommended that the valve be placed back at the tank, which is usually a considerable distance from the injector. As with the manual on/off valve, the solenoid valve must NEVER be placed between the injector and the point of injection.

# Hammonds Model 6T-2M Injection System Manual

## LOCATING THE SYSTEM

In rack loading installations, there are usually two primary location choices for installing the system.

The first choice would be remote from the island at some point in the main product line between the product pump and where the pipe goes underground or overhead, leading to the island itself. This type installation is usually used in cases where the entire product handled by the island will be treated. Although the additive can be turned off, if two loading arms on the island are being used simultaneously, it is not possible to isolate one and not the other for injection.

### INJECTOR LOCATION FOR OFF-ISLAND INSTALLATION

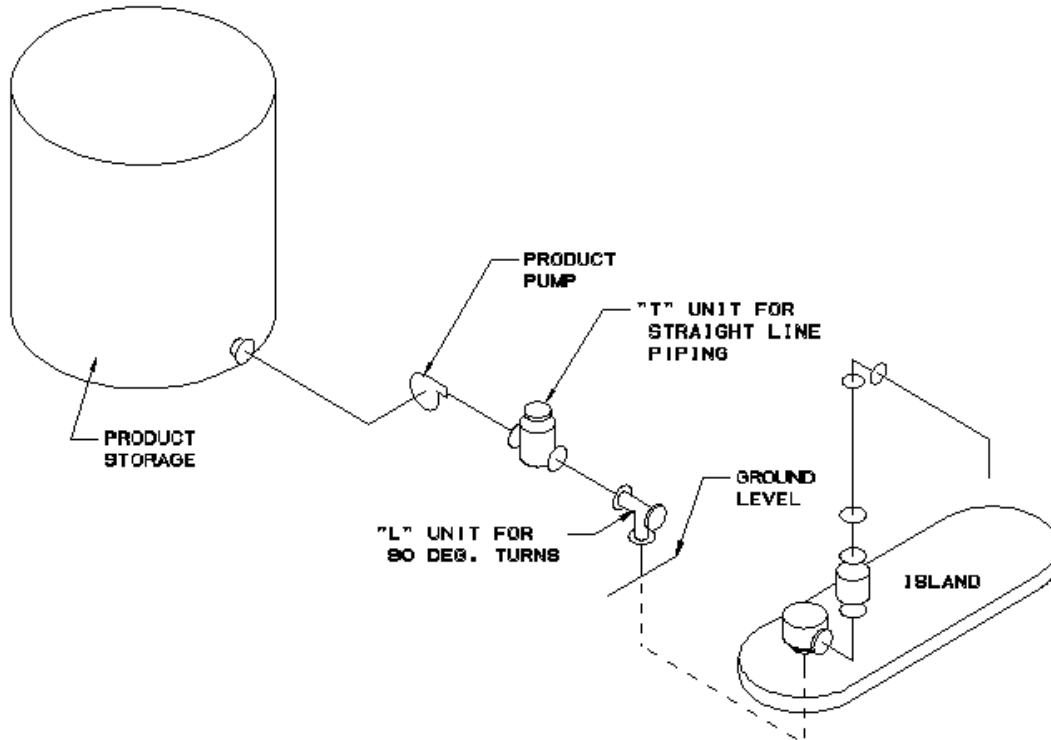

The injector should not be located between the product pump and the product storage tank. In remote island installations such as illustrated above, the 6T can be used in either horizontal or vertical straight runs of pipe.

## Hammonds Model 6T-2M Injection System Manual

The other option for basic location is on the island itself. In this installation, a unit is usually placed on each of the loading arms, providing for the selective injection of any combination. The unit may be installed at any point from where the pipe exits the ground to where the swivel arm begins for the hose drop. This location offers versatility in that a single injector can be shared by up to four (4) separate users, injecting different additives on demand. There is almost always a convenient "spot" to install the system, either in a 90° elbow or in a short run of straight-line pipe.

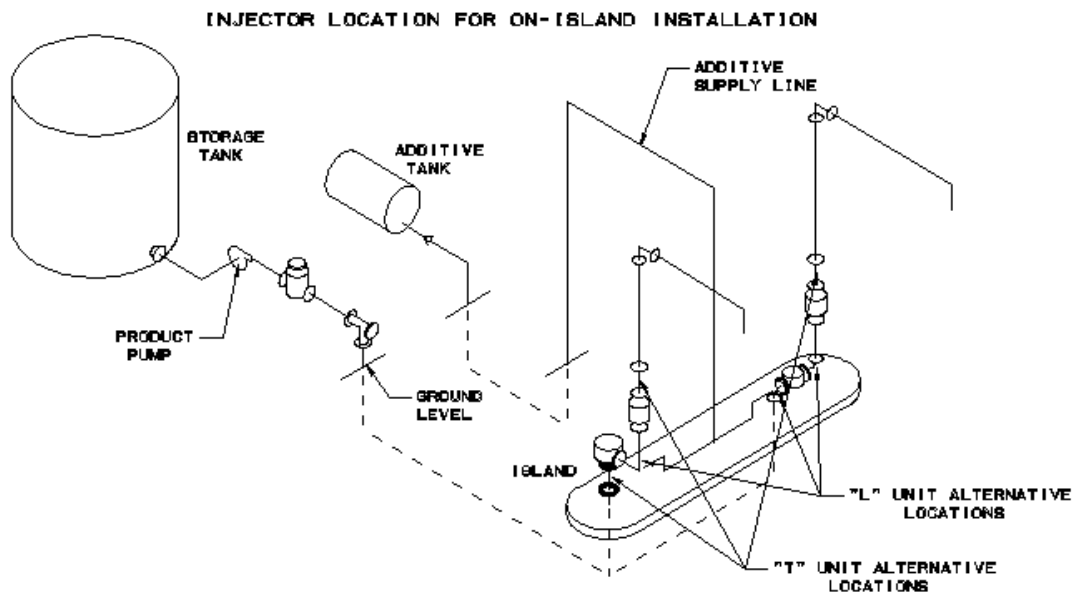

Location of the injector at the island is usually handy to existing wiring conduits for card controls, allowing for easy installation of the on/off solenoid. Units can be configured for horizontal or vertical installation.

# Hammonds Model 6T-2M Injection System Manual

## **CHOOSING THE SPOT FOR INSTALLATION OF THE UNIT ON THE ISLAND**

Most island loading arms will present at least two and sometimes three mounting options. Consideration should be given to serviceability and traffic of personnel and equipment such as swinging hoses.

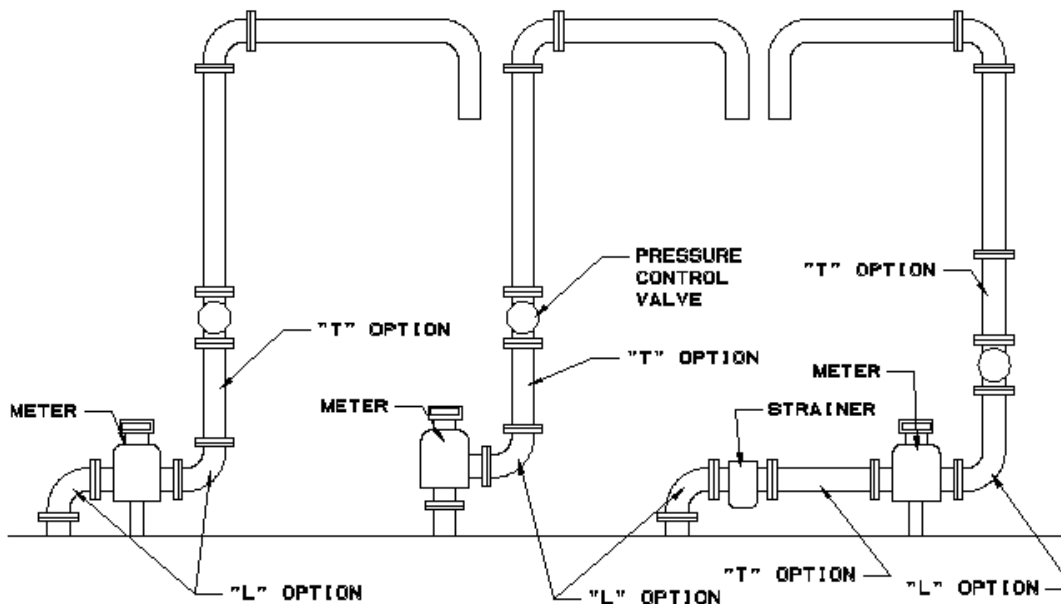

## **ADDITIVE SUPPLY SYSTEM**

The additive tank should always be placed as close to the injector as possible. Ideally, the tank should be at the same level or slightly higher than the unit providing a flooded suction to the injector. If this is not possible, the injector, depending upon the application and the model of pump, will pull a suction lift. **NOT ALL PUMPS WILL.** The end user is responsible to make sure there are absolutely no leaks in the suction line of the injector. A pin hole will prevent the system from priming and/or operating efficiently. Tape all connections carefully with Teflon sealant. Consult your engineering department or the factory for assistance with any application concerns.

The following illustration identifies the basic components necessary for a complete additive supply system. Study the information provided for each component, as each part plays a vital role in the overall performance of the system.

# Hammonds Model 6T-2M Injection System Manual

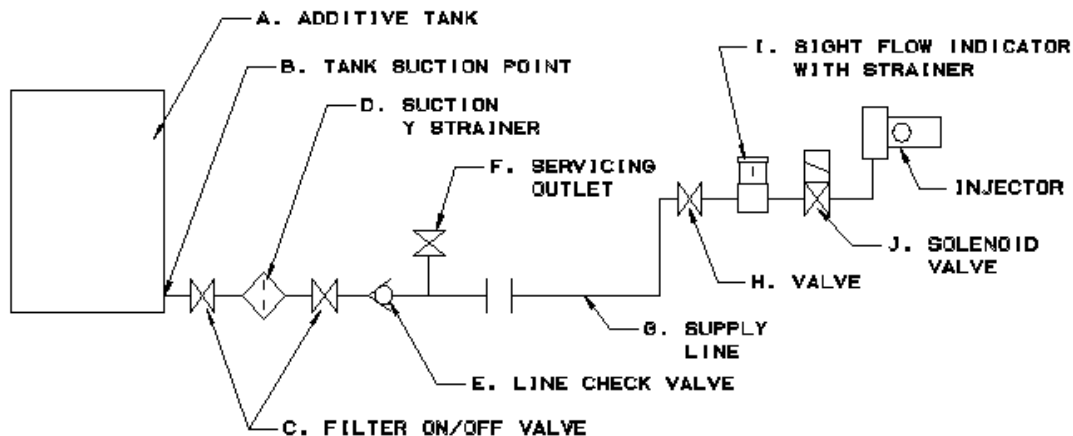

**A. THE ADDITIVE TANK:** Additive tanks should be constructed of materials compatible with the additive. Tanks should be new and free from scale, rust and corrosion. Any loose surface material inside the tank will fall into suspension and contaminate the additive after startup. Care should be taken to prevent sandblast sand from entering the tank during the manufacturing process. If water is used for testing, the tank should be dried internally to prevent the formation of rust.

**B. TANK SUCTION POINT:** Suction should never be taken from the very bottom of the tank. Should foreign material of any kind be present, the line will become plugged, causing either failure or erratic performance of the system. Remember, there are components in every additive system that are sensitive to contamination. Suction should be taken at least 1" off the bottom of the tank to prevent the introduction of foreign sediments off the bottom.

**C. FILTER ON/OFF VALVE:** A full opening ball valve of at least the diameter of the additive supply line should be placed on either side of the filter or suction Y-strainer. Two valves are necessary in

order to clean the strainer without losing the entire line full of additive. This will prevent having to re-prime the system each time the strainer is cleaned.

**D. SUCTION Y-STRAINER:** A Y-type strainer with a 50-60 mesh screen is ideal for removing most harmful particles from the additive supply. Any smaller mesh will cause excessive friction loss. If the openings are too large, the strainer will do little to protect the system.

**E. SUCTION LINE CHECK VALVE:**  
**Notice: This check valve is only used in very rare occasions. Consult the factory before use.** This suction line check valve is used to provide additional insurance that the primed line will not drain back between uses. If the additive supply line is properly installed without leaks, it will remain full even when not in use. This line check valve is suggested as an extra precaution to prevent loss of system prime. The valve should be made of a material compatible with the additive, and have a "feather light" opening pressure. The valve should be a ball type with a synthetic material that is very light, preferably with no spring. The gravity of the material will seat the ball. Consult the

# Hammonds Model 6T-2M Injection System Manual

factory if there is any question regarding the proper valve for this application.

**F. SERVICING OUTLET:** The service outlet provides a means for operating a manual pump in the additive supply line. The pump can be connected and used for purging air from the line while priming. Although this is an option, the factory strongly recommends the accessory for easy startup and service. A simple tee and on/off valve is used for this purpose.

**G. ADDITIVE SUPPLY LINE:** The size of the delivery line to the injector is important when long distances are involved. Use the following chart for determining line size.

0 - 500 PPM up to 25'	1/2"
25 to 50'	3/4"
50 to 100'	1"
Over 1000 PPM up to 25'	3/4"
25 to 50'	1"
50 to 100'	1-1/4"

The above lines are a suggestion only. Make certain to use at least 1 size larger than the inlet size of the pump you are supplying. Consult the factory for greater requirements.

**H. SIGHT FLOW/STRAINER VALVE:**

This valve is also a full opening ball valve that is used to isolate the additive line when cleaning the strainer in the Sight Flow Indicator.

**I. SIGHT FLOW INDICATOR/SUCTION STRAINER:**

This strainer is used to provide indication of the system's operation, as well as add extra protection for the solenoid valve from trash and contamination. When properly installed, this indicator will give the operator proof that the system is operating properly.

**J. SOLENOID VALVE:**

This valve is provided for the remote operation of the system. It is important that the valve is a direct acting type that requires no pressure from the line in which it controls. The materials of the valve body and the elastomers are extremely important as any reaction with the additive can cause failures. Consult the factory to make certain that the valve and trim materials are compatible. Also, make certain that the orifice in the valve is large enough for the application. Any restriction in this orifice will cause the system to work harder to perform the given ratio of injection.

# Hammonds Model 6T-2M Injection System Manual

## ADDITIVE TANK INSTALLATION

Placement of the additive tank and related supply lines relative to the injector is critical to performance of any additive system. The following illustrations will provide information regarding the various types of tank installations and their connection to the additive injectors. Hammonds injectors offer the greatest flexibility in tank and supply line installation of any additive injection system on the market. Since no pumps or feed mechanisms are necessary, installation goes faster and at less cost. The choice of appropriate components and pipe sizes, along with leak-free installation, will determine if the system works properly and consistently.

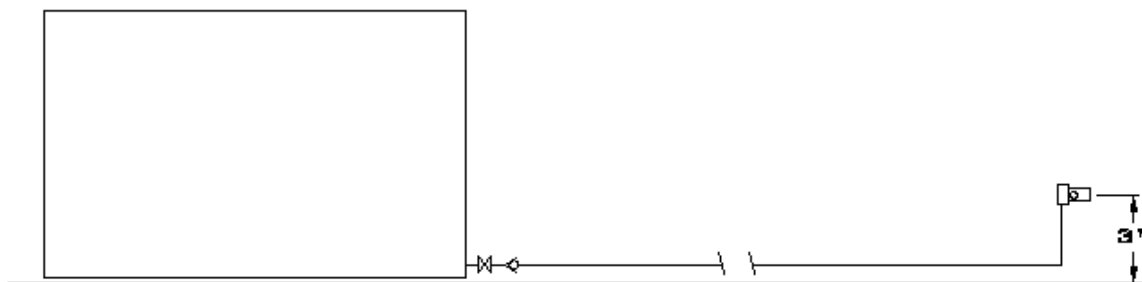

### ***OPTION 1 - ABOVE GROUND TANK, ABOVE GROUND DELIVERY LINES***

This installation calls for both the tank and the supply lines to be above ground. The bottom of the tank is very close to the ground, and the injector is approximately 3' above ground. Using a 4' diameter tank, this would provide a variable net suction head to the injector of +1' when the tank is full to a worst condition of a -3' when the tank is almost empty. A Y type strainer should be located at the tank. A full opening ball valve located on each side of the strainer, with a light action (less than 1/2 PSI) check valve installed to assist in holding the prime. Install a ball valve just upstream of the Sight Flow Indicator, and if one is to be used, install the solenoid-operated valve between the Sight Flow Indicator and the injector. Use the table listed in the previous section for selection of pipe diameter.

# Hammonds Model 6T-2M Injection System Manual

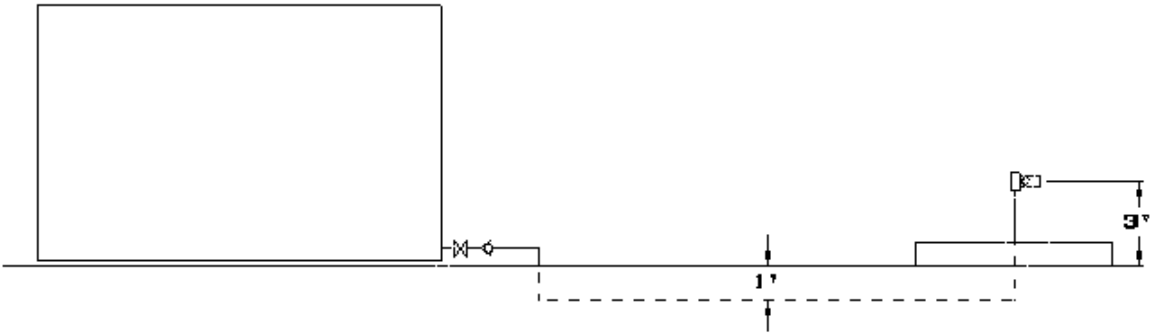

## ***OPTION 2 - ABOVE GROUND TANK, BELOW GROUND DELIVERY LINES***

This option is basically the same as that in Option 1. The effect of burying lines below the ground level does not affect final suction conditions since the head gained in going below ground level offsets the additional lift at the injector end. It is necessary to make certain on initial startup and priming of the system that all air is removed from the supply lines and the various components.

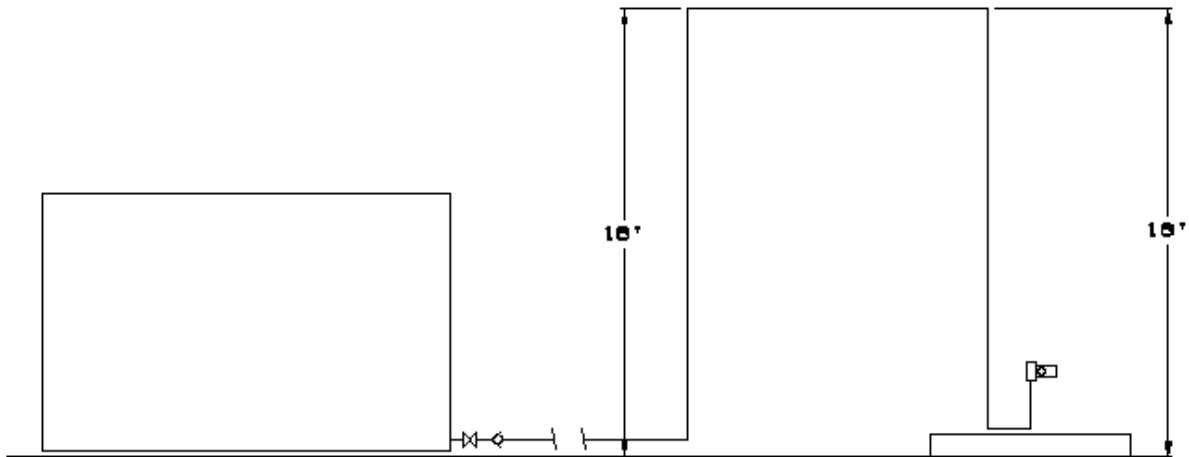

## ***OPTION 3 - ABOVE GROUND TANK WITH HIGH CLEARANCE OBSTACLE***

This application for a non-pressurized additive system is difficult to achieve in the real world because fittings and check valves notoriously leak. . This is not recommended. If equipment is installed in this manner it will void the factory warranty.

# Hammonds Model 6T-2M Injection System Manual

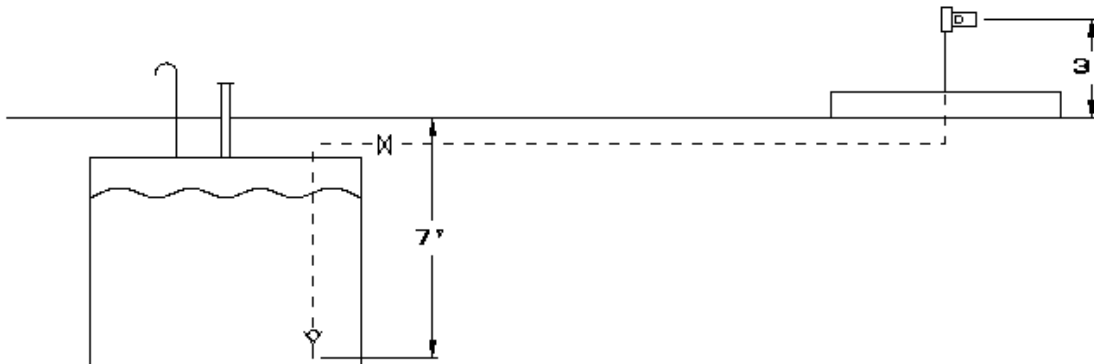

## **OPTION 4 - BELOW GROUND TANK, BELOW GROUND LINES**

This is the most difficult application for a non-pressurized additive supply. In this case, the pump must overcome a negative lift equal to the total distance between the bottom of the tank and the injector above ground.

**This is not recommended because fittings and check valves leak. If equipment is installed in this manner it will void the factory warranty.**

## **PREPARATION FOR CALIBRATION AND STARTUP**

**Before attempting to start the system or make calibration, please read the following information carefully.**

During startup and calibration, you will be bleeding the system of air, collecting samples of additive during calibration, and checking for possible leaks throughout the system. Provisions should be made for cleanup of spilled fluid. You will have some losses during these procedures. If the additive being handled is flammable, fire safety precautions should be taken. Since the installation may also be tested at this time, extreme caution should be used in checking for leaks of the mainline. If you

wish to set the system up for leak-free testing and calibration with zero spillage, please consult your local distributor or the factory for help in doing so. Hammonds is glad to suggest necessary parts and procedures for “zero spill” startup and calibration.

### **A WORD ABOUT ADDITIVES**

Most additives being used in fuels today have at least some degree of toxicity. Many are very dangerous. Extreme caution should be taken in handling additives. Remember, the additive is placed under pressure when being injected into the line, and when

# Hammonds Model 6T-2M Injection System Manual

collecting samples during calibration, some spillage may occur. Be careful; wear protective clothing including eye protection. Be sure you have facilities to wash off any additive that may come in contact with your skin. Read all additive manufacturers safety precautions and Material Safety Data Sheets, following them to the letter.

## HERE IS WHAT YOU WILL NEED:

- Appropriate safety protection equipment
- Eye protection in the form of safety goggles
- An assortment of wrenches that fit the various fittings on the system. Note: two (2) 10" Crescent wrenches will normally take care of any adjustments to fittings you may have to make (one to hold the fitting, and one to hold the adjacent fitting.).

- Some clean rags for cleanup of spilled material.
- A marked graduated glass bottle that is marked in either CC's or ounces. (At least 16 ounces)
- A stop watch.
- A means of determining the flow rate of the main system.
- A small pocket calculator.
- A clipboard is helpful with pad of paper.
- ***At Least One, And Preferably Two Extra Helpers.***
- A large container to collect the output of the pump while you are not actually calibrating the system.

**REMEMBER:** Any plumbing system varies with temperature and fluid being pumped. The system also changes as parts of the pump wear.

## CALIBRATION AND STARTUP

**IF YOUR INJECTOR SYSTEM IS EQUIPED WITH CALIBRATION GAUGES, FOLLOW THE INSTRUCTIONS FOR THEIR USE IN THE BACK OF THIS MANUAL.**

### PROPER ADDITIVE INJECTION RATIOS

Although volumetric calibration at atmospheric pressure will bring you within an acceptable range of additive injection, the only true evaluation for proper ratio is the ASTM D-5006 evaluation for fuel system ice inhibitor (FSII). Do not depend on volumetric calibration to ensure on-spec performance because line pressures can vary and additive injector parts wear

over time. Contact Hammonds Fuel Additives, Inc. for supply of quality fuel system ice inhibitor and fuel testing procedures.

Please follow these steps in their given order. Read them over carefully before starting, and then follow them to the letter. If there is any part of the procedure that is not clear, consult your local distributor or the factory directly.

1. Make certain the additive tank is at least ½ full of the proper additive.
2. Open the suction valve between the tank and the pump. This valve may be located at any point between the additive tank and the injector.

## Hammonds Model 6T-2M Injection System Manual

3. All systems are calibrated at the factory to customer specified requirements. So if adjustments are necessary, they should only be minor. If this is the case, go directly to Step 6.

4. **FOR HAMMONDS PUMPS ONLY:** If you are starting from scratch with your calibration and adjustment, loosen the stroke adjustment locking screws located on the bottom of the pump body directly under the stroke adjustment knob. This will allow the stroke adjustment to be moved.

5. **FOR HAMMONDS PUMPS ONLY:** Adjust the stroke adjustment knobs located on the pump body to approximately 50%. **CAUTION:** Do not turn this adjustment with excessive force. If they are difficult to adjust, simply rotate the shaft coupling just ahead of the pump as you make the adjustment. You will find this makes the adjustment much easier.

6. Lock the stroke adjustment locking screws down firmly.

7. Set the calibration valve (3-way valve) in the bleed or "calibration position." This is done by making certain that the handle on the valve is positioned so that additive will exit through the short open tube.

8. Make certain all product connections going to and from the system are in their proper, locked position to ensure safe, leak free flow of product through the turbine. Double check the flow direction arrows located on the turbine housing to ensure that the system is installed properly.

9. At this point, consider the information you will have to gather during the next few steps of the calibration process.

A. What will the flow rate through the unit be?

B. What is the length of time that the calibration will cover?

C. What is the amount of additive in ounces or cc's that you will need to collect based on the time duration of the calibration?

**You should have the answers to all these questions before your first calibration trial run.** If you alone can do it all, fine; however, it is suggested that you have an assistant give you that information as it will be needed to determine whether the system needs to be increased or decreased in output.

10. Before starting the product flow through the system, make certain everyone understands that you will run the system for, let's say, one (1) minute. Even shorter runs are fine, especially if you are running at high flow rates.

11. Place the measured graduate under the calibration tube. Put on your eye protection!

12. At the command of the timekeeper, or that person watching the flow meter, start the product pump.

13. Give the system a few seconds to gather momentum and flow through the turbine. Notice if the turbine is turning. The coupling between the pump and the turbine housing should be spinning. You may not be able to see the coupling on some models; however, you see the shaft. On enclosed systems, there may be a plug that can be removed on the side of the gearcase mounting in order to view the shaft and coupling.

## Hammonds Model 6T-2M Injection System Manual

14. If the pump is being started up for the first time, it will take a few seconds to prime itself and begin discharging fluid from the calibration tube. Is your eye protection on? If not, **PUT IT ON NOW!**

15. As soon as the pump begins discharging a clear, air free stream of fluid from the calibration tube, you will be ready to stop the system and begin your calibration. At this point, the system is primed.

- **Hammonds recommends using the Suction Calibration Gauge or a pressure simulating calibration device shown in the back of this manual.**

16. You will now prepare to make your first actual calibration run. Notice the setting on the flow meter, set your stopwatch at zero, and empty your collected additive back into the tank, putting the bottle back under the calibration tube.

17. When ready, start the system again. Stop it at the decided time interval or meter reading. Calculate the amount of product that traveled through the system. Measure the amount of additive gathered, and record the amount of elapsed time.

18. It will be at this time that you will have to calculate how much additive should be collected for the amount of fuel that the system pumped. This, of course, depends upon the ratio that is required. The following example is the easiest way of explaining the procedure without getting too complicated. It is not the only way....just one way. Use it if you like.

*Example condition:* Amount of product pumped: 500 gallons

*Ratio of additive desired:* 250 PPM (parts per million)

It is assumed that the operator will know how much product is being pumped through the system in a given length of time. If, for example, you have a meter that registers the flow in gallons, you simply record the gallons at the beginning of the timed run, and then again at the end of the run. If you ran for one (1) minute, you simply subtract the beginning number on the meter from the number registered after the run. This will give you the gallons per minute (GPM). Having to make this calculation is the only reason for timing the run. You can accomplish the same result by just watching the meter and stopping the system when you have totaled the desired amount of gallons through the system. In any case, you must know the amount of product passing through the system before calibration can begin.

First, change the gallons pumped into ounces by multiplying 500 x 128 (128 oz to a gallon). The answer is 64,000 ounces.

Second, divide by 1,000,000. The answer is .06. Since you are dealing in 1/1,000,000 (one part per million) of the total for your ratio, you must find out what 1/1,000,000 of the 500 gallons is, .06 ounces is 1/1,000,000<sup>th</sup> (one part per million) of 500 gallons.

Third, multiply the .06 x 250 (for 250 PPM ratio). The answer is 15 ounces.

So, you should collect 15 ounces of additive for every 500 gallons of fuel pumped.

# Hammonds Model 6T-2M Injection System Manual

These are all large, round numbers. You may, for example, only be running at 100 GPM, not 500. Use the same procedure; just change the numbers to fit your application.

No two systems will ever perform exactly the same. For this reason, the procedures given for calibration are general in nature.

Obviously, it is impossible to provide a graph or table that would be absolutely accurate in every case. With that in mind, all tables and graphs should be used as general guidelines. Remember, the calculated, timed and measured output that you gather is absolute. Trust your figures and your calculations.

## ADDITIVE CHART

GALLONS	135 PPM	270 PPM	1000 PPM
100	1.7 OZ.	3.4 OZ.	12.8 OZ.
200	3.4 OZ.	6.9 OZ.	25.6 OZ.
400	6.9 OZ.	13.8 OZ.	51.2 OZ.
500	8.6 OZ.	17.2 OZ.	64.0 OZ.
700	12.0 OZ.	24.0 OZ.	89.6 OZ.
1000	17.2 OZ.	34.5 OZ.	128.0 OZ.

## TROUBLESHOOTING THE SYSTEM

The following conditions are given as a means of troubleshooting the system. Each condition lists a number of possible causes. In most cases, trouble can be solved by the use of this section. Please read it carefully before attempting repairs, or making changes in the system.

### THE TURBINE IS NOT TURNING

- A.** Insufficient flow to turn the turbine. A minimum of about 350 GPM must be present to start the system. 400 GPM is the minimum for normal calibrated operation.
- B.** A rag or some other object is jammed in the line, preventing the turbine from turning.
- C.** A diverter valve is blocked downstream of the system, blocking the fuel flow through the system.

**D.** A defueling valve is left open on a truck or hydrant system, starving the turbine for product flow.

**E.** The pump and turbine have been knocked out of alignment during shipment or installation, causing a binding of the coupling.

### THE TURBINE IS TURNING AND PUMP IS RUNNING, BUT WITH NO OUTPUT

**A.** Pump is air-locked. In some cases where there is a very long line running from the injector head and the point of injection into the system, there is sufficient air volume to cause the pump to act as a compressor. It is not able to open the valves throughout the system and, therefore, cannot pull a suction of fluid to the pump. Crack the fitting ferrule nut on the discharge side of the calibration valve and allow it to remain open until the pump begins pumping.

## Hammonds Model 6T-2M Injection System Manual

This is rare, but can happen in some cases of unusual installations.

**B.** One or more of the suction or discharge check valves is not working. While the pump is running, tap on the side of the valves, one at a time. This will generally jar them loose. The poppet and seals are very small, and will sometimes become stuck. After the valve is loosened and has a supply of fluid, usually it will not stick again.

**C.** The pump is not getting additive. Check the valve between the pump and the tank. Check all connections in the line between the pump and the tank.

**D.** The vent on the tank is not open, causing the pump to pull a vacuum. Open the vent. Check to see if the cap has been removed from the dryer cartridge, if so equipped.

**E.** The pump stroke is set at zero. Check to see if the locking screws have been left loose, allowing the adjustment knobs to rotate to zero percent (0%) of stroke.

**F.** The additive tank is empty...don't laugh, it happens.

### **THE INJECTOR IS OPERATING BUT WITH REDUCED OUTPUT**

**A.** Leaking suction line or trash in discharge check valve.

**B.** Air leak in suction side of system.

**C.** Defective tubing or piping on suction side.

**D.** Leaks in threaded connections - suction side.

**E.** If so equipped, a relief valve on injector may be bleeding part of the output back to suction. Relief valve may not be working, or retaining nut may have vibrated loose causing valve to fail entirely, bleeding output back to suction.

**F.** Injector diaphragm may be pulled out in back causing injector to pump in forward portion of stroke only. This will not create a visible leak but will reduce output by 50%. It usually happens after many hours of operation.

### **PREVENTATIVE MAINTENANCE**

1. Check pump gearbox oil level monthly. To check the pump gearbox oil level, remove the plug on the side of the gearbox (1/8" Allen head pipe plug) that is even with the output shaft of the gearcase. Oil should be filled to this level. To add oil, remove vented cap on top of gearbox. Refill with Mobil Synthetic All-temperature Gear Oil, #SHC 626 or equal. Do not overfill as oil will boil out of the vent if level is too high. Fill until oil comes out the side port. Overfilling will overheat the unit and reduce injector output. **Note: this procedure is not required on factory lubricated and sealed gearboxes used after 12/2016.**

2. Make certain to use only clean, fresh additive that has been stored in a sealed drum. Most additives are moisture sensitive. Some will form heavy crystals if allowed to accumulate moisture. These crystals will stop the pump in very short order, if not cause calibration to be changed due to clogging of valves and other parts.

3. Check the additive filter screen at least every month, more often if there is an indication of possible contamination.

4. Check the system for leaks at every use. This is an extremely important procedure since some additives are flammable, caustic, and corrosive and

## Hammonds Model 6T-2M Injection System Manual

may have environmental impact if a spill occurs.

5. Check for leaks at the seal that is located at the exit point of the turbine output shaft as it leaves the turbine housing. This should be at each operation. Leakage at this point usually indicates the mechanical seal inside the turbine housing is leaking. A leak here will usually indicate fuel, and is not only a possible fire hazard; fuel in the bearings of the turbine will quickly wash away lubricant and cause damage to the gearbox.

6. Check the fittings for leakage around the suction filter, if one is used on the pump. Check this fitting each time the filter is changed or cleaned. This would apply to top and bottom of the glass tube used in the Suction Sight Flow Indicator. Make certain there are no leaks in the suction line. A very small leak will either change the operation of the pump, or prevent it from operating altogether.

7. Visually check around the pump head to make certain there is no leaking of additive around the fluid ends. If there is, check the tightness of the head bolts. These screws must be tightened to 40 inch pounds each. Under tightening will allow leaks and the diaphragm to work free, reducing the output of the fluid end. Over tightening will damage the diaphragm. An additive leak that appears to be coming from inside the pump power frame under the stroke mechanism usually indicates a ruptured diaphragm.

8. Pump diaphragms or plunger seals require replacement at different intervals, depending on the total hours of service, the speed of the particular installation and the percent of stroke being utilized. As an example, a system that operates eight

hours every day is considered continuous duty. If the system is operating at above 120 RPM pump speed, it is considered severe, and finally, if the pump setting is greater than 50% stroke, the diaphragms or plunger seals will experience greater fatigue and, therefore fail sooner than one that is set at 10 - 25% stroke.

Depending on the operating conditions (duty cycle, speed, and % of stroke and pressure), diaphragms or plunger seals can be expected to last from 6 - 18 months. It is recommended that critical duty installations begin initial service by checking the diaphragms or plunger seals after 6 months. Normally, checking only one of the pump heads will give an indication of the condition of others in the system. Examine the diaphragm or plunger seal for wear. If it is in good condition, perform the next examination following nine months of service. If the condition remains good, examine again after twelve months. On a diaphragm, check for signs of breaks in the Teflon surface, cracking or swelling of the rubber backing and failure of the fastener in the rear of the diaphragm. White crazing on the surface of the Teflon face is normal. If any signs of swelling or deformity of the Teflon is seen, the diaphragm must be replaced. Remember, only the Teflon face is resistant to the additive. The rubber backing will soon deteriorate after the Teflon face is broken and leaks additive to the reinforced back.

As a general rule, diaphragms or plunger seals should be replaced every twelve months. Every 6 months under extreme operating conditions. Careful monitoring of your installation may reduce or extend that period. You should establish a maintenance schedule that

# Hammonds Model 6T-2M Injection System Manual

gives reasonable life, and will prevent unexpected failures and unscheduled downtime.

9. Check grease around the eccentric drive bearing in the pump every six months. Use a good quality white lithium spray lubricant. A little common sense here is important. The bearing needs enough lubricant to keep the surface of the bearing and the face of the crosshead coated. Excessive amounts only attract dirt and make visual inspection of the various parts difficult.

10. Check the eccentric drive bearing for tightness every 30 days. Replace the bearing if there is excessive looseness in between the inner and outer race of the bearing. Make certain there is no looseness felt between the bearing and the output shaft of the gearbox.

11. Visually check the stroke adjustment parts of each pump every 30 days. These parts are held in by a series of small screws. If these fasteners are allowed to work loose, the parts soon fail. Movement in the stroke adjustment knob and the stroke locking screw during operation will indicate this condition. If any movement is observed in these parts, check closer for looseness. Thread compound must be used, along with appropriate torque settings on these fasteners.

12. All stroke adjustment parts of each pump fluid end will eventually need replacement. Again, this will depend on the severity of service. As a general rule of thumb, a complete rebuild, including the cross head, cross head slide bearings, stroke adjustment cam and power frame cover, should be performed during this major maintenance. Large fluid ends as

used in the "L" pump heads generally create more wear on these parts, and should, therefore, be checked regularly to establish a reasonable maintenance schedule.

13. The 6T turbine should be removed from the line, disassembled and inspected at the following intervals.

*Total Operating Time Based on Daily Service Averages*

0-4 hours	5-8 hours	8+ hours
24 months	12 months	8 months

As with injection pumps, the inspection of one unit will provide a good indication of general wear where multiple unit installations are involved. There are only four parts to inspect; the mechanical seal, two sealed shaft bearings and the oil seal where the turbine shaft exits the housing.

**Mechanical Seal:** A mechanical seal is normally serviceable for many years. Be extremely careful as you disassemble, inspect and reassemble the seal. The smallest scratch or particle of dirt left on the seal face will cause it to leak. The seal should be replaced, if at all possible.

**Turbine Shaft Bearings:** Some of the bearings used are factory lubricated and sealed. Others in the assembly are high-speed, needle or roller type bearings. These needle bearings need to be greased at least every 12 months depending upon the application (refer to the PM schedule). A grease fitting is provided at the top of the turbine housing, below the gearbox, to re-grease the turbine bearings. Use a good quality, all temperature, and high-speed bearing grease. Continue to apply grease until you see the grease exit the bearing housing around the top bearing. Wipe off

## Hammonds Model 6T-2M Injection System Manual

the excess grease. All bearings should be checked for excessive tolerance between the inner and outer race.

If bearings with excessive wear remain in the system, the turbine shaft will move excessively and cause the mechanical seal to leak. Bearings are inexpensive, replace if possible.

Shaft Oil Seal: Some turbines, depending upon the model, have an additional shaft seal. This lip seal is located on the turbine shaft as it exits the turbine housing. Its

primary purpose is to keep rainwater and dust out of the turbine housing. During inspection of the shaft, if moisture is indicated in the turbine housing, or if the shaft has any rust present, the seal must be replaced. Make certain the shaft is clean and free of any corrosion and rust before reinstallation of a new seal. Steel wool can be used to remove any minor corrosion. Since the shaft is stainless steel, there should be very little corrosion present.

### PREVENTATIVE MAINTENANCE SCHEDULE

**NOTE:** It is important to read the previous pages on preventative maintenance. These intervals are general, and may vary according to individual applications and severity of service.

SERVICE FUNCTION	0-4 HRS DAILY	5-8 HRS DAILY	8+HRS DAILY
Check pump gear oil level	Monthly	Monthly	Monthly
Check additive filter screen	Monthly	Monthly	Monthly
Check system for additive/fuel leaks	Daily	Daily	Daily
Inspect diaphragms/plunger seals	12 Months	6 Months	3 Months
Replace diaphragms/plunger seals	12 Months	As needed	As needed
Check eccentric bearing grease	6 Months	3 Months	Monthly
Check stroke adjustment parts for looseness	Monthly	Monthly	Monthly
Replace stroke adjustment parts	24 Months	As needed	As needed
Disassemble and inspect turbine housing and internal parts	24 Months	12 Months	8 Months
Grease turbine...use zirk fitting below gear reducer	12 Months	6 Months	3 Months

# Hammonds Model 6T-2M Injection System Manual

## DESICCANT DRYER

Your Hammonds additive system may include a custom additive tank. The additive tank may come equipped with a desiccant dryer cartridge. These units come in several different sizes.

Most systems come equipped with the standard 3/4" cartridge. This unit is attached to the tank via a short length of black rubber hose. The cartridge has a housing constructed of a clear poly material and is filled with a blue colored desiccant crystal. All these units are shipped from the factory with a small yellow cap on the unattached end of the cartridge.

Some systems may come equipped with a large canister measuring approximately 2" diameter and 10" in length. These units perform the same function, just on a larger scale. Due to their greater capacity, they last longer between service. These units are sealed from the factory by a small, plastic plug which is located either on the bottom or one side of the canister.

The purpose of all desiccant dryers is simply to remove moisture from the air as the system breathes. All tanks or portable sources of additive supply must be vented to atmosphere in order for the injector to operate. If moisture in this venting air is not removed, some additives are either ruined or seriously damaged. Fuel system icing inhibitor (FSII), for example, is designed to seek out water in a

fluid. So, when enough moisture is absorbed into the container, the FSII is diluted and at some point will be ruined. Biobor® JF, an anti-fungal material, will form crystals in the presence of moisture and not only perform unsatisfactorily as an additive, but will stop up pumps and lines as well.

The following instructions apply to all desiccant cartridges:

**A.** Remove the yellow cap or plug when the system is placed into service.

**B.** Observe the color of the desiccant. The original color is blue. As moisture is absorbed, the color will change to pink. When the cartridge is completely pink, it should either have its contents removed, dried and replaced, or the entire unit replaced.

**C. NOTE:** The contents can be removed from plastic container, placed on a pan and baked at 400°F in a conventional oven until the moisture has been removed. When the color blue returns, the cooled material may be reinstalled into plastic containers and is again ready for service.

**D.** Color change and cartridge life is totally dependent on humidity. The more moist the air, the shorter the life. Keeping it dry is especially important if additive is not consumed rapidly. Check daily and service as needed.

# Hammonds Model 6T-2M Injection System Manual

\* NOTE:  
FLOW SHOWN IS LEFT - RIGHT  
MAY BE BUILT RIGHT - LEFT

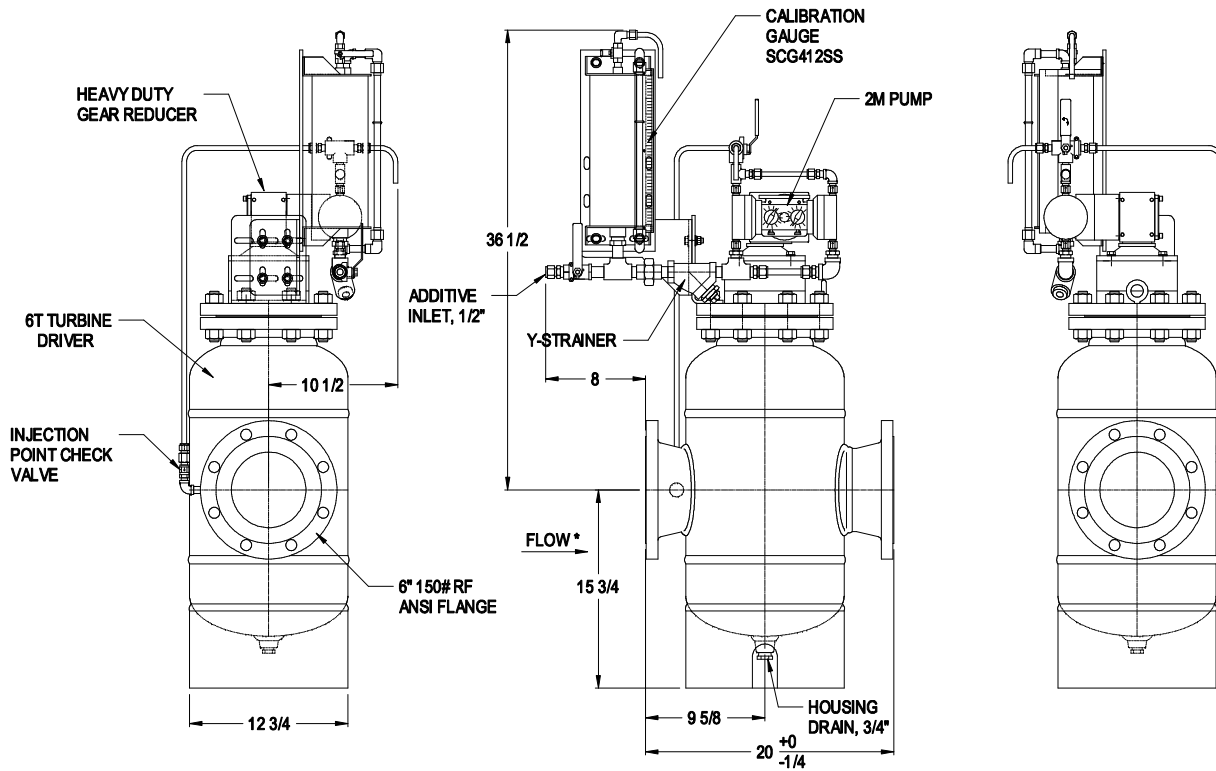
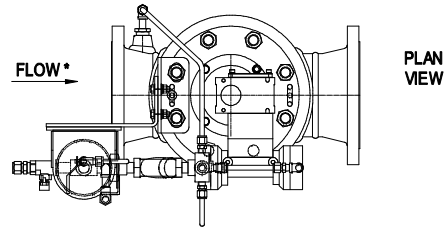

<p><b>*TOLERANCES*</b> ALL DIMENSIONS ARE IN INCHES UNLESS OTHERWISE SPECIFIED.</p>		<p>THIS PRINT IS CONFIDENTIAL AND IS THE PROPERTY OF HAMMONDS TECHNICAL SERVICES</p>		<p><b>HAMMONDS TECHNICAL SERVICES, INC.</b></p>	
<p>*TOL. DECIMALS: .XXX= +/- .005 .XX= +/- .015 .X= +/- .030 FRAC.= +/- 1/16</p>		<p>*TOL. ANGLES: +/- .5 DEGREES</p>		<p>SCALE <b>NPS</b>      APPROVED PART NUMBER</p>	
<p>SURFACE FINISH 125</p>		<p>*CONCENTRICITY: .005 T. I. R.</p>		<p>DATE <b>10/16/18</b>      DRAWN BY <b>SS</b></p>	
<p>*REMOVE BURRS AND BREAK EDGES .005 MIN.</p>		<p>THIS PRINT SHALL NOT BE LOANED, COPIED OR REPRODUCED IN WHOLE OR IN PART, NOR SHALL THE CONTENTS BE REVEALED IN ANY MANNER TO ANYONE UNLESS WRITTEN PERMISSION IS OBTAINED FROM HAMMONDS TECHNICAL SERVICES.</p>		<p>REVISSED</p>	
<p>DRAWING NO. <b>6T1</b></p>		<p>LEVELS <b>221-226</b></p>		<p>DRAWING TITLE <b>HAMMONDS MODEL 6T-2M</b></p>	
<p>DATE <b>10/16/18</b></p>		<p>BY <b>SS</b></p>		<p>DRAWING NUMBER <b>7840</b></p>	
<p>TO SER# <b>X</b></p>		<p>DATE <b>X</b></p>		<p>SCG412SS</p>	

NO.	INITIAL RELEASE	10/16/18	SS	X	APPVD	X	X	X
REVISION	DATE	BY	APPVD	DATE	TO SER#	DATE	DATE	DATE

# Hammonds Model 6T-2M Injection System Manual

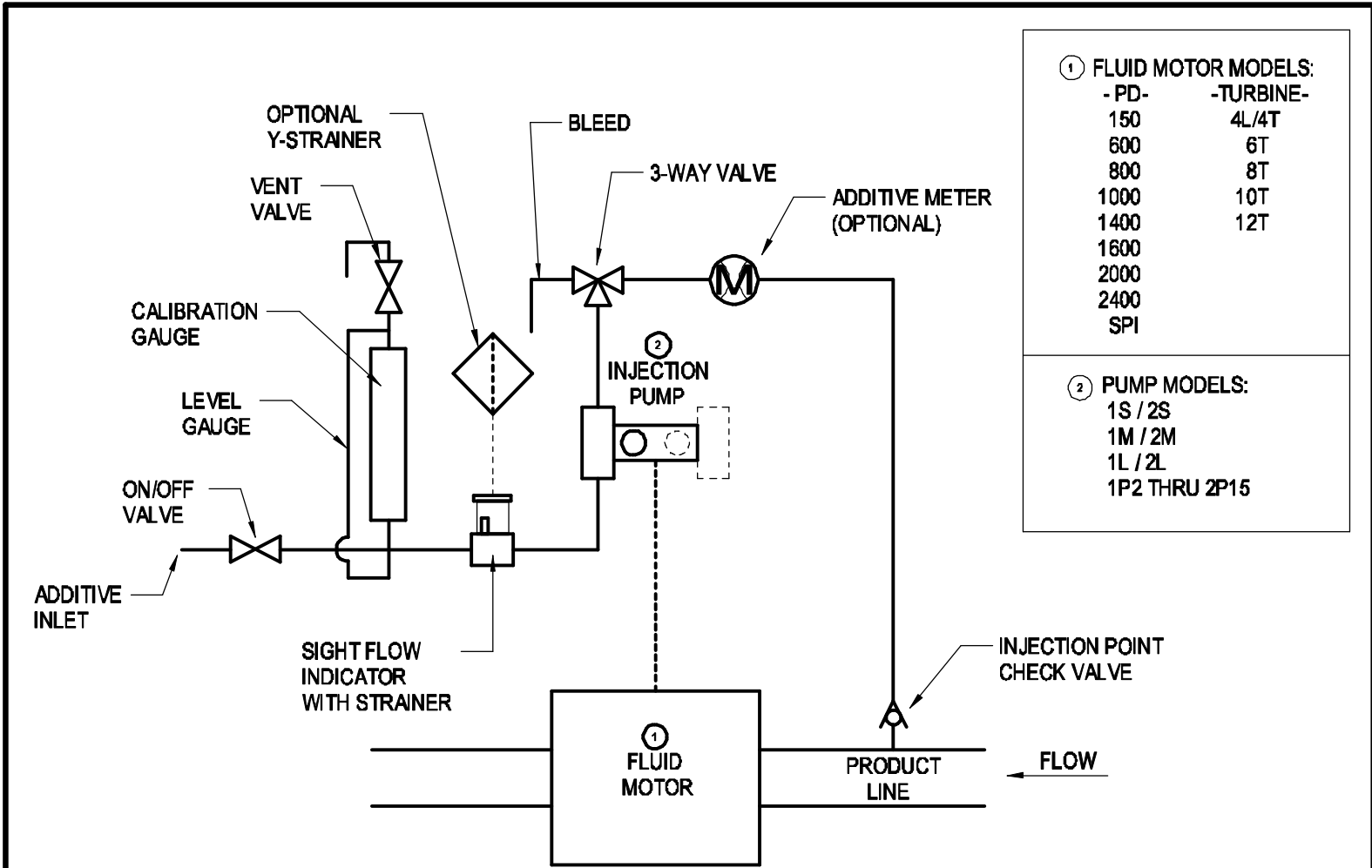

- |                       |           |
|-----------------------|-----------|
| ① FLUID MOTOR MODELS: |           |
| - PD-                 | -TURBINE- |
| 150                   | 4L/4T     |
| 600                   | 6T        |
| 800                   | 8T        |
| 1000                  | 10T       |
| 1400                  | 12T       |
| 1600                  |           |
| 2000                  |           |
| 2400                  |           |
| SPI                   |           |
| ② PUMP MODELS:        |           |
| 1S / 2S               |           |
| 1M / 2M               |           |
| 1L / 2L               |           |
| 1P2 THRU 2P15         |           |

*TOLERANCES* ALL DIMENSIONS ARE IN INCHES UNLESS OTHERWISE SPECIFIED.				THIS PRINT IS CONFIDENTIAL AND IS THE PROPERTY OF HAMMONDS TECHNICAL SERVICES		HAMMONDS TECHNICAL SERVICES, INC.	
*TOL. DECIMALS: .XXX= +/- .005 .XX= +/- .015 .X= +/- .030 FRAC.= +/- 1/16		*TOL. ANGLES: +/- .5 DEGREES		SCALE <b>NPS</b>		APPROVED PART NUMBER	
*CONCENTRICITY: .005 T.I.R.		*REMOVE BURRS AND BREAK EDGES .005 MIN.		DATE <b>08/09/10</b>		DRAWN BY <b>SS</b>	
DRAWING <b>1707</b> LEVELS <b>135</b> VIEW <b>I</b>				DRAWING TITLE <b>HYDRAULIC SCHEMATIC</b>			
FROM SER# <b>X</b> DATE <b>X</b> TO SER# <b>X</b> DATE <b>X</b>				FOR SCG"SS" MODELS			
NO. <b>X</b> REVISION		DATE		BY		APPVD	
						DRAWING NUMBER <b>6331</b>	

# Hammonds Model 6T-2M Injection System Manual

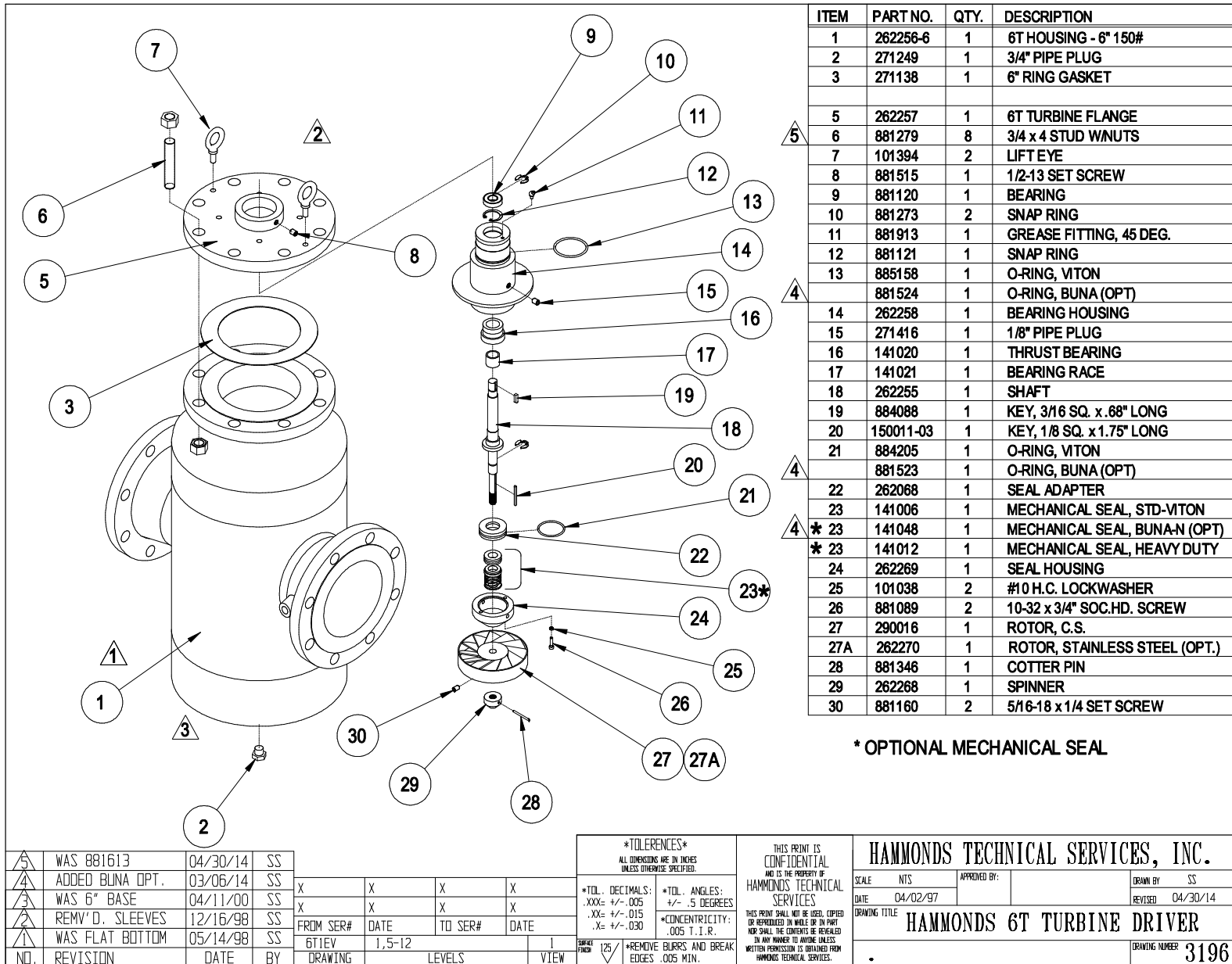

ITEM	PART NO.	QTY.	DESCRIPTION
1	262256-6	1	6T HOUSING - 6" 150#
2	271249	1	3/4" PIPE PLUG
3	271138	1	6" RING GASKET
5	262257	1	6T TURBINE FLANGE
6	881279	8	3/4 x 4 STUD W/NUITS
7	101394	2	LIFT EYE
8	881515	1	1/2-13 SET SCREW
9	881120	1	BEARING
10	881273	2	SNAP RING
11	881913	1	GREASE FITTING, 45 DEG.
12	881121	1	SNAP RING
13	885158	1	O-RING, VITON
	881524	1	O-RING, BUNA (OPT)
14	262258	1	BEARING HOUSING
15	271416	1	1/8" PIPE PLUG
16	141020	1	THRUST BEARING
17	141021	1	BEARING RACE
18	262255	1	SHAFT
19	884088	1	KEY, 3/16 SQ. x .68" LONG
20	150011-03	1	KEY, 1/8 SQ. x 1.75" LONG
21	884205	1	O-RING, VITON
	881523	1	O-RING, BUNA (OPT)
22	262068	1	SEAL ADAPTER
23	141006	1	MECHANICAL SEAL, STD-VITON
* 23	141048	1	MECHANICAL SEAL, BUNA-N (OPT)
* 23	141012	1	MECHANICAL SEAL, HEAVY DUTY
24	262269	1	SEAL HOUSING
25	101038	2	#10 H.C. LOCKWASHER
26	881089	2	10-32 x 3/4" SOC.HD. SCREW
27	290016	1	ROTOR, C.S.
27A	262270	1	ROTOR, STAINLESS STEEL (OPT.)
28	881346	1	COTTER PIN
29	262268	1	SPINNER
30	881160	2	5/16-18 x 1/4 SET SCREW

\* OPTIONAL MECHANICAL SEAL

NO.	REVISION	DATE	BY	DRAWING	LEVELS	VIEW
1	WAS 881613	04/30/14	SS			
2	ADDED BUNA OPT.	03/06/14	SS	X	X	X
3	WAS 6" BASE	04/11/00	SS	X	X	X
4	REMOVED SLEEVES	12/16/98	SS			
5	WAS FLAT BOTTOM	05/14/98	SS			

*TOLERANCES*	
ALL DIMENSIONS ARE IN INCHES UNLESS OTHERWISE SPECIFIED.	
*TOL. DECIMALS: .XXX= +/- .005 .XX= +/- .015 .X= +/- .030	*TOL. ANGLES: +/- .5 DEGREES *CONCENTRICITY: .005 T.I.R.
FRM SER#	DATE
TO SER#	DATE
6T1EV	1,5-12
1	
125	
*REMOVE BURRS AND BREAK EDGES .005 MIN.	

**HAMMONDS TECHNICAL SERVICES, INC.**

SCALE: NTS      APPROVED BY: \_\_\_\_\_      DRAWN BY: SS

DATE: 04/02/97      REVISED: 04/30/14

DRAWING TITLE: **HAMMONDS 6T TURBINE DRIVER**

DRAWING NUMBER: **3196**

# Hammonds Model 6T-2M Injection System Manual

ITEM	PART NO.	QTY.	DESCRIPTION
1	886200-05	1	5:1 REDUCER
	886200-07	1	7.5:1 REDUCER
	886200-10	1	10:1 REDUCER
	886200-15	1	15:1 REDUCER
	886200-20	1	20:1 REDUCER
	886200-25	1	25:1 REDUCER
	886200-30	1	30:1 REDUCER
	886200-40	1	40:1 REDUCER
	886200-50	1	50:1 REDUCER
	886200-60	1	60:1 REDUCER
	886200-80	1	80:1 REDUCER
	886200-100	1	100:1 REDUCER
2	282071	1	OUTPUT SHAFT, SINGLE ECC
3	282072	1	OUTPUT SHAFT, DUAL ECC
4	282075	1	KEY, 3/16" SQ x 3"
5	103058	2	EXTERNAL SNAP RING
* 6	282069	1	OUTPUT SPACER
* 7	885269	4	M6-1 x 30MM SOC HD CAP
* 8	885270	4	M6 HC LOCK WASHER
* 9	282070	1	PUMP MOUNT BLOCK
* 10	885274	4	5/16-18 x 2" SOC HD CAP
* 11	882352	4	5/16 HC LOCK WASHER
* 12	881882	1	BEARING
* 13	881999	1	SPACER
* 14	881157	1	HD DRIVE BEARING
* 15	101045	1	EXTERNAL SNAP RING
16	282068	1	INPUT SPACER
17	282045	1	INPUT HEIGHT SPACER (OPT)
18	881066	1	1/2" FLEX COUPLING HALF
19	231077	1	RUBBER SPIDER
20	881022	1	5/8" FLEX COUPLING HALF
21	282021	1	SHAFT EXTENSION, 1/2" (OPT)
	282056	1	SHAFT EXTENSION, 5/8" (OPT)
22	881398	2	1/4-20 SET SCREW
23	885271	4	3/8-16 x 3-1/2" HEX BOLT
24	881580	4	3/8-16 x 4-1/2" HEX BOLT (OPT)
25	881083	4	3/8" LOCK WASHER
26	282073	1	SHAFT COVER SPACER
27	282074	1	SHAFT COVER
28	885268	2	M6-1 x 16MM SOC HD CAP
29	885270	2	M6 HC LOCK WASHER

\* DOUBLE QTY FOR PUMP ON BOTH SIDES

**COMPLETE ASSEMBLY NUMBER INCLUDES:**  
 BASE MODEL #, RATIO, OPTIONS  
 EXAMPLE: 88620 S - 10 - 4T X E H

<p><b>S</b> = Single Output <b>D</b> = Dual Output</p>	<p><b>RATIO</b></p> <table style="width: 100%; border-collapse: collapse;"> <tr><td>05 = 5:1</td></tr> <tr><td>07 = 7.5:1</td></tr> <tr><td>10 = 10:1</td></tr> <tr><td>15 = 15:1</td></tr> <tr><td>20 = 20:1</td></tr> <tr><td>25 = 25:1</td></tr> <tr><td>30 = 30:1</td></tr> <tr><td>40 = 40:1</td></tr> <tr><td>50 = 50:1</td></tr> <tr><td>60 = 60:1</td></tr> <tr><td>80 = 80:1</td></tr> <tr><td>100 = 100:1</td></tr> </table>	05 = 5:1	07 = 7.5:1	10 = 10:1	15 = 15:1	20 = 20:1	25 = 25:1	30 = 30:1	40 = 40:1	50 = 50:1	60 = 60:1	80 = 80:1	100 = 100:1	<p><b>4T</b> = 4T or 4L  <b>8T</b> = for 6T - 12T  <b>XX</b> = other</p>
05 = 5:1														
07 = 7.5:1														
10 = 10:1														
15 = 15:1														
20 = 20:1														
25 = 25:1														
30 = 30:1														
40 = 40:1														
50 = 50:1														
60 = 60:1														
80 = 80:1														
100 = 100:1														
<p><b>S</b> = STD (Extension not req'd)  <b>X</b> = Shaft Ext &amp; HT Spacer</p>	<p><b>E</b> = Ecc Drive  <b>A</b> = 3/4" Keyed  <b>B</b> = 5/8" Keyed</p>	<p><b>H</b> = Horiz Input (Std)  <b>V</b> = Vertical Input</p>												

DRAWING	LEVELS	VIEW	
GEARED	136-138	I	

FROM SER#	DATE	TO SER#	DATE
X	X	X	X

**\*TOLERANCES\***  
 ALL DIMENSIONS ARE IN INCHES UNLESS OTHERWISE SPECIFIED.

<p><b>*TOL. DECIMALS:</b>          .XXX = +/- .005          .XX = +/- .015          .X = +/- .030          FRAC. = +/- 1/16</p>	<p><b>*TOL. ANGLES:</b>          +/- .5 DEGREES</p>
<p><b>*CONCENTRICITY:</b>          .005 T.I.R.</p>	

**\*REMOVE BURRS AND BREAK EDGES .005 MIN.**

THIS PRINT IS CONFIDENTIAL AND IS THE PROPERTY OF HAMMONDS TECHNICAL SERVICES

THIS PRINT SHALL NOT BE USED, COPIED OR REPRODUCED IN WHOLE OR IN PART NOR SHALL THE CONTENTS BE REVEALED IN ANY MANNER TO WHOMEVER WITHOUT WRITTEN PERMISSION IS OBTAINED FROM HAMMONDS TECHNICAL SERVICES.

<b>HAMMONDS TECHNICAL SERVICES, INC.</b>			
SCALE: NTS	APPROVED PART NUMBER	DRAWN BY: SSS	
DATE: 12/05/16	SEE TABLE	REVISED: .	
DRAWING TITLE: <b>HD WORM GEAR REDUCER</b>			
			DRAWING NUMBER: <b>7486</b>

# Hammonds Model 6T-2M Injection System Manual

ITEM	PART NO.	QTY.	DESCRIPTION
1	101014	1	POWER FRAME
2	221001	2	DIAPHRAGM, M
3	222002	2	FLUID END, M
4	882949	12	LOCK WASHER, #10 INT. TOOTH
5	101037	8	SCREW, 10-32 x 1 1/2"
6	101842	2	CROSSHEAD GUIDE
7	101007	4	RETURN SPRING
8	101006	2	CROSSHEAD
9	101152	4	SLIDE BEARING
10	101005	2	STROKE ADJUSTMENT CAM
11	101003	2	CAM GUIDE
12	101001	2	STROKE ADJUSTMENT KNOB
13	101002	1	POWER FRAME COVER
14	101004	2	LOCK SCREW
15	101009	8	SCREW, 8-32 x 3/8"
16	881086	8	LOCKWASHER, #6
17	101010	8	SCREW, 6-32 x 3/8"
18	881089	4	SCREW, 10-32 x 3/4"
18A	881680	4	SCREW, 10-32 x 2 1/4" (OPT)
19	102463	4	CHECK VALVE, 1 PSI, AFLAS
	102464	4	CHECK VALVE, 1 PSI, VITON (OPT)
	102642	4	CHECK VALVE, 1 PSI, KALREZ (OPT)
20	222001	2	ADAPTER RING, M
21	222003	2	BACK UP RING
22	881170	8	SCREW, #10 x 5/8" BUTTON HD
23	101038	8	LOCKWASHER, #10 HC
24	882911	1	CHECK VALVE, 5 PSI, AFLAS (STD)
	101576	1	CHECK VALVE, 5 PSI, VITON (OPT)
	102643	1	CHECK VALVE, 5 PSI, KALREZ (OPT)
25	101088	1	3/8 x 1/4 FNPT TUBE ADAPTER

△	NEW CHECK VALVES	03/15/04	SS				
△	WAS #101933	03/15/04	SS				
△	WAS #102263	09/03/02	SS				
△	WAS #101008	08/99	SS				
△	ADDED INJ CHK VLV	01/23/98	SS				
△	REVISION	DATE	BY	FROM SER#	DATE	TO SER#	DATE
				X	X	X	X

*TOLERANCES*		THIS PRINT IS CONFIDENTIAL AND IS THE PROPERTY OF HAMMONDS TECHNICAL SERVICES	
ALL DIMENSIONS ARE IN INCHES UNLESS OTHERWISE SPECIFIED.		THIS PRINT SHALL NOT BE LOANED, COPIED OR REPRODUCED IN WHOLE OR IN PART NOR SHALL THE CONTENTS BE REVEALED IN ANY MANNER TO ANYONE UNLESS WRITTEN PERMISSION IS OBTAINED FROM HAMMONDS TECHNICAL SERVICES.	
*TOL. DECIMALS: .XXX± +/- .005 .XX± +/- .015 .X± +/- .030	*TOL. ANGLES: +/- .5 DEGREES *CONCENTRICITY: .005 T. I. R.	*REMOVE BURRS AND BREAK EDGES .005 MIN.	

<b>HAMMONDS TECHNICAL SERVICES, INC.</b>			
SCALE: NTS	APPROVED BY:	DRAWN BY: SS	REVISED: 03/15/04
DATE: 03/15/99			
DRAWING TITLE: <b>HAMMONDS 2M PUMP</b>			
			DRAWING NUMBER: <b>0629</b>

# Hammonds Model 6T-2M Injection System Manual

**1**

**2**

**3**

**\* WARNING... FAILURE TO TORQUE SCREWS PROPERLY TO 40 IN. LBS. WILL REDUCE PUMP HEAD PERFORMANCE, RESULTING IN INSUFFICIENT INJECTION RATIO.**

**10 ROTATE DIAL FULLY IN OPPOSITE DIRECTION (CLOCKWISE) BRINGING DIAPHRAGM AT REST AGAINST ADAPTER RING.**

**WARNING! FAILURE TO FOLLOW THIS PROCEDURE WILL RESULT IN DIAPHRAGM DEFORMATION AND PREMATURE FAILURE.**

**4**

**5**

<b>HAMMONDS TECHNICAL SERVICES, INC.</b>			
FOR TECHNICAL ASSISTANCE CALL HAMMONDS TECHNICAL SERVICES (800) 582-4224	SCALE NTS	APPROVED BY:	DRAWN BY S.S.
	DATE 2/1/82		REVISED 4/10/82
DRAWING TITLE <b>"M" DIAPHRAGM REPLACEMENT</b>			
			DRAWING NUMBER <b>1460</b>

# Hammonds Model 6T-2M Injection System Manual

ITEM	PART NO.	QTY.	DESCRIPTION
1	102757	1	POWER FRAME, HD ALUM.
2	221001	2	M DIAPHRAGM, TEFLON FACED, STD.
	221008	2	M DIAPHRAGM, VITON (OPTION)
3	222002	2	FLUID END, M
4	882949	12	LOCK WASHER, #10, INT. TOOTH
5	101037	10	SCREW, 10-32 x 1 1/2"
6	101038	12	LOCK WASHER, #10 H.C.
7	101007	4	RETURN SPRING
8	101006	2	CROSSHEAD
9	101152	4	SLIDE BEARING
10	101005	2	STROKE ADJUSTMENT CAM
11	102758	1	PUMP FRAME COVER, HD ALUM.
12	101001	2	STROKE ADJUSTMENT KNOB
13	101670	1	STROKE INDICATOR
14	882352	2	LOCK WASHER, 5/16" SS ( OPTION )
15	883863	2	SCREW, 5/16-18 x 1 1/4" SS ( OPTION )
15A	882351	2	SCREW, 5/16-18 x 2 3/4" SS ( OPTION )
16	881126	4	SCREW, 10-32 x 1/2"
17	881301	4	SCREW, 10-32 x 1"
17A	883170	4	SCREW, 10-32 x 2 1/2" ( OPTION )
18	102463	4	CHECK VALVE, AFLAS, STD.
	102464	4	CHECK VALVE, VITON ( OPTION )
	102642	4	CHECK VALVE, KALREZ ( OPTION )
19	882911	1	CHECK VALVE, 5 PSI, AFLAS
	101576	1	CHECK VALVE, 5 PSI, VITON (OPT)
	102643	1	CHECK VALVE, 5 PSI, KALREZ (OPT)
20	101088	1	3/8 x 1/4 FNPT TUBE ADAPT.
21	222001	2	ADAPTER RING
22	222003	2	BACK UP RING
23	102480	2	O-RING
24	881170	8	SCREW, 10-32 x 5/8" SS

NO.	REVISION	DATE	BY	APPVD
△	INITIAL RELEASE	02/24/10	SS	X

DRAWING	LEVELS	VIEW
INJECTOR	40, 67-73, 77-83, 139-141, 143, 208, 255	1

FROM SER#	DATE	TO SER#	DATE
X	X	X	X

*TOLERANCES*	
ALL DIMENSIONS ARE IN INCHES UNLESS OTHERWISE SPECIFIED.	
*TOL. DECIMALS:	*TOL. ANGLES:
.XXX = +/- .005	+/- .5 DEGREES
.XX = +/- .015	
.X = +/- .030	
FRAC. = +/- 1/16	
*CONCENTRICITY: .005 T.I.R.	
*REMOVE BURRS AND BREAK EDGES .005 MIN.	

HAMMONDS TECHNICAL SERVICES, INC.		
SCALE: NTS	APPROVED PART NUMBER	DRAWN BY: SS
DATE: 02/24/10		REVISED: *
DRAWING TITLE: HAMMONDS 2M PUMP		
HEAVY DUTY		DRAWING NUMBER: 6100-2

# Hammonds Model 6T-2M Injection System Manual

**NOTE: MARK STROKE SETTING BEFORE REMOVING ANY PART**

1 REMOVE LOCK SCREW  
2 REMOVE ADJUSTMENT KNOB  
3 REMOVE STROKE INDICATOR PLATE AND CAM GUIDE / COVER  
4 REMOVE SCREWS HOLDING FLUID END. REMOVE FLUID END.

FLUID END

**1**

**\* WARNING... FAILURE TO TORQUE SCREWS PROPERLY TO 40 IN. LBS. WILL REDUCE PUMP HEAD PERFORMANCE, RESULTING IN INSUFFICIENT INJECTION RATIO.**

11 REINSTALL SCREWS, TAKING EACH ONE DOWN BY HAND UNTIL IT STOPS. TIGHTEN SCREWS TO 40 IN. LBS. \* IN THE ORDER SHOWN BELOW. TORQUE EACH SCREW IN THE PATTERN, THEN REPEAT THE TORQUE SEQUENCE ONLY ONCE !

**4**

5 PRESS DIAL KNOB BACK ON AND ROTATE COUNTER CLOCKWISE UNTIL DIAPHRAGM HAS CLEARED SURFACE OF POWER FRAME AND CROSSHEAD HAS CLEARED DRIVE BEARING.  
6 REMOVE SNAP RING  
7 SLIDE DRIVE BEARING OFF  
8 UNSCREW OLD DIAPHRAGM

HD POWER FRAME  
CROSSHEAD

**2**

**\* WARNING! FAILURE TO FOLLOW THIS PROCEDURE WILL RESULT IN POOR PUMP PERFORMANCE WITH DIAPHRAGM DEFORMATION AND PREMATURE FAILURE.**

10 ROTATE DIAL FULLY IN OPPOSITE DIRECTION (CLOCKWISE) BRINGING DIAPHRAGM AT REST AGAINST POWER FRAME.

**4**

9 WITH DIAL SET IN SAME COUNTER CLOCKWISE (FULL OUT) POSITION, INSTALL NEW DIAPHRAGM, THREADING INTO CROSSHEAD ALL THE WAY. DO NOT OVER-TIGHTEN!

**3**

12 ROTATE DIAL COUNTER CLOCKWISE ENOUGH TO INSTALL DRIVE BEARING. INSTALL SNAP RING.

13 REMOVE DIAL KNOB. REINSTALL CAM GUIDE / COVER AND STROKE INDICATOR PLATE REINSTALL ADJUSTMENT KNOB AND POSITION IT ON ORIGINAL % SETTING. INSTALL LOCK SCREW, LOCK DIAL IN PLACE.

**5**

**NOTE: AFTER THIS PROCEDURE IS COMPLETE, YOU MUST RECALIBRATE THE INJECTOR TO YOUR SPECIFICATIONS.**

**5**

FOR TECHNICAL ASSISTANCE CALL  
HAMMONDS TECH. SVS.  
(281) 999-2900

**HAMMONDS TECHNICAL SERVICES, INC.**

SCALE NTS	APPROVED	PART NUMBER	DRAWN BY SS
DATE 02/26/2009			REVISED -
DRAWING TITLE "M" DIAPHRAGM REPLACEMENT			
HEAVY DUTY PUMP SERIES			DRAWING NUMBER 1460-1

DRAWING	LEVELS	VIEW
1460	10, 11	1

# Hammonds Model 6T-2M Injection System Manual

ITEM	PART NO.	QTY.	DESCRIPTION
1	152081	1	CAP
2	152080	1	BODY
3	151010	2	GASKET, NEOPRENE
4	151009	1	GLASS
5	152025	1	FILTER ELEMENT
6	151005	1	PIPE PLUG, 1/4"
<b>OPTIONAL:</b>			
3	151013	2	GASKET, VITON
3	151025	2	GASKET, BUNA-N
7	102787	1	1/4" CHK VLV, 5 PSI, AFLAS

**NOTE:** ADAPTER FITTINGS VARY PER APPLICATION... SEE YOUR ASSEMBLY ILLUSTRATION

**IMPORTANT!...** NOTE DIRECTION OF FLOW

ADDED CHECK VALVE OPTION & NOTE		05/23/14	SS	X	DRAWING	LEVELS	VIEW	
					1349	1,2	1	
ADDED PLUG REVISION		03/24/10	SS	X	FROM SER#	DATE	TO SER#	DATE
					X	X	X	X

**\*TOLERANCES\***  
 ALL DIMENSIONS ARE IN INCHES UNLESS OTHERWISE SPECIFIED.

\*TOL. DECIMALS:  
 .XXX= +/- .005  
 .XX= +/- .015  
 .X= +/- .030  
 FRAC.= +/- 1/16

\*TOL. ANGLES:  
 +/- .5 DEGREES

\*CONCENTRICITY:  
 .005 T.I.R.

\*REMOVE BURRS AND BREAK EDGES .005 MIN.

THIS PRINT IS CONFIDENTIAL AND IS THE PROPERTY OF HAMMONDS TECHNICAL SERVICES

THIS PRINT SHALL NOT BE USED, COPIED OR REPRODUCED IN WHOLE OR IN PART NOR SHALL THE CONTENTS BE REVEALED IN ANY MANNER TO ANYONE UNLESS WRITTEN PERMISSION IS OBTAINED FROM HAMMONDS TECHNICAL SERVICES.

<b>HAMMONDS TECHNICAL SERVICES, INC.</b>			
SCALE	ITS	APPROVED PART NUMBER	DRAWN BY
DATE	10/21/91	152020	SS
DRAWING TITLE		REVISED	
<b>HI-VOL SIGHT FLOW INDICATOR</b>		05/23/14	
			DRAWING NUMBER
			1349

# Hammonds Model 6T-2M Injection System Manual

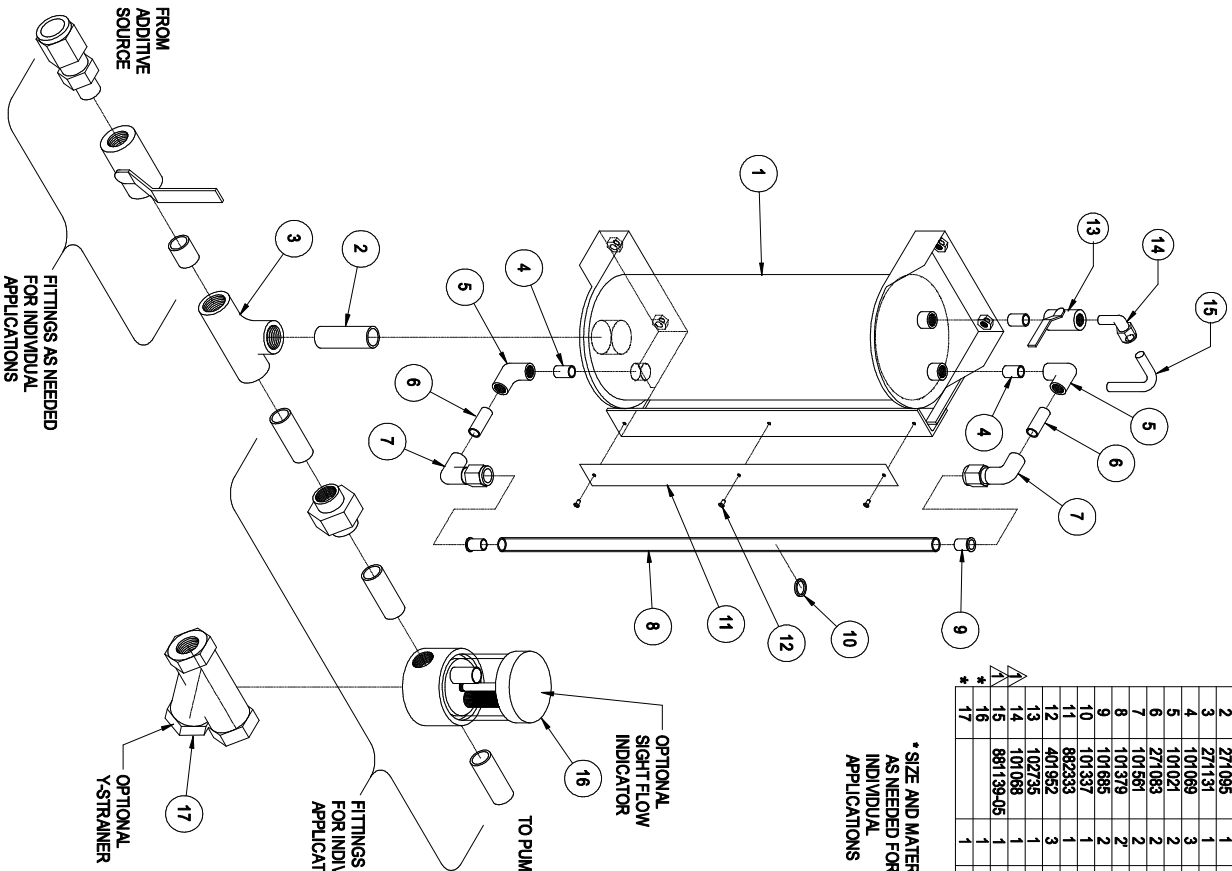

ITEM	PART NO.	QTY.	DESCRIPTION
1	102489-01	1	RESERVOIR
2	271095	1	NIPPLE 3/4" x 2"
3	271131	1	TEE 3/4"
4	101089	3	PIPE NIPPLE 1/4" x CL
5	101021	2	ELBOW, 1/4" FNPT
6	271083	2	PIPE NIPPLE, 1/4" x 2"
7	101561	2	TUBE ADAPT, 1/2" x 1/4" ELBOW
8	101379	2	1/2" TEFLON TUBE
9	101685	2	1/2" INSERT
10	101337	1	O-RING
11	882333	1	STRIP GALUGE
12	401952	3	DRIVE SCREW, #8
13	102735	1	VENT VALVE, 1/4"
14	101088	1	TUBE ELBOW, FNPT, 3/8" x 1/4"
15	881398-05	1	VENT TUBE, 3/8"
16		1	SIGHT FLOW INDICATOR (OPT)
17		1	Y-STRAINER (OPT)

\* SIZE AND MATERIAL AS NEEDED FOR INDIVIDUAL APPLICATIONS

FITTINGS AS NEEDED FOR INDIVIDUAL APPLICATIONS

FITTINGS AS NEEDED FOR INDIVIDUAL APPLICATIONS

*TITLES* IN ORIGINAL DESIGN *TOL. DECIMALS* .0005 .001 .002 .005 .010 .015 .020 .030 .040 .050 .060 .070 .080 .090 .100 .125 .150 .175 .200 .250 .300 .375 .450 .500 .625 .750 .875 1.000 1.250 1.500 2.000 2.500 3.000 4.000 5.000 6.000 8.000 10.000 12.000 15.000 20.000 25.000 30.000 40.000 50.000 60.000 80.000 100.000 125.000 150.000 200.000 250.000 300.000 400.000 500.000 600.000 800.000 1000.000 1250.000 1500.000 2000.000 2500.000 3000.000 4000.000 5000.000 6000.000 8000.000 10000.000 12500.000 15000.000 20000.000 25000.000 30000.000 40000.000 50000.000 60000.000 80000.000 100000.000 125000.000 150000.000 200000.000 250000.000 300000.000 400000.000 500000.000 600000.000 800000.000 1000000.000 1250000.000 1500000.000 2000000.000 2500000.000 3000000.000 4000000.000 5000000.000 6000000.000 8000000.000 10000000.000 12500000.000 15000000.000 20000000.000 25000000.000 30000000.000 40000000.000 50000000.000 60000000.000 80000000.000 100000000.000 125000000.000 150000000.000 200000000.000 250000000.000 300000000.000 400000000.000 500000000.000 600000000.000 800000000.000 1000000000.000 1250000000.000 1500000000.000 2000000000.000 2500000000.000 3000000000.000 4000000000.000 5000000000.000 6000000000.000 8000000000.000 10000000000.000 12500000000.000 15000000000.000 20000000000.000 25000000000.000 30000000000.000 40000000000.000 50000000000.000 60000000000.000 80000000000.000 100000000000.000 125000000000.000 150000000000.000 200000000000.000 250000000000.000 300000000000.000 400000000000.000 500000000000.000 600000000000.000 800000000000.000 1000000000000.000 1250000000000.000 1500000000000.000 2000000000000.000 2500000000000.000 3000000000000.000 4000000000000.000 5000000000000.000 6000000000000.000 8000000000000.000 10000000000000.000 12500000000000.000 15000000000000.000 20000000000000.000 25000000000000.000 30000000000000.000 40000000000000.000 50000000000000.000 60000000000000.000 80000000000000.000 100000000000000.000 125000000000000.000 150000000000000.000 200000000000000.000 250000000000000.000 300000000000000.000 400000000000000.000 500000000000000.000 600000000000000.000 800000000000000.000 1000000000000000.000 1250000000000000.000 1500000000000000.000 2000000000000000.000 2500000000000000.000 3000000000000000.000 4000000000000000.000 5000000000000000.000 6000000000000000.000 8000000000000000.000 10000000000000000.000 12500000000000000.000 15000000000000000.000 20000000000000000.000 25000000000000000.000 30000000000000000.000 40000000000000000.000 50000000000000000.000 60000000000000000.000 80000000000000000.000 100000000000000000.000 125000000000000000.000 150000000000000000.000 200000000000000000.000 250000000000000000.000 300000000000000000.000 400000000000000000.000 500000000000000000.000 600000000000000000.000 800000000000000000.000 1000000000000000000.000 1250000000000000000.000 1500000000000000000.000 2000000000000000000.000 2500000000000000000.000 3000000000000000000.000 4000000000000000000.000 5000000000000000000.000 6000000000000000000.000 8000000000000000000.000 10000000000000000000.000 12500000000000000000.000 15000000000000000000.000 20000000000000000000.000 25000000000000000000.000 30000000000000000000.000 40000000000000000000.000 50000000000000000000.000 60000000000000000000.000 80000000000000000000.000 100000000000000000000.000 125000000000000000000.000 150000000000000000000.000 200000000000000000000.000 250000000000000000000.000 300000000000000000000.000 400000000000000000000.000 500000000000000000000.000 600000000000000000000.000 800000000000000000000.000 1000000000000000000000.000 1250000000000000000000.000 1500000000000000000000.000 2000000000000000000000.000 2500000000000000000000.000 3000000000000000000000.000 4000000000000000000000.000 5000000000000000000000.000 6000000000000000000000.000 8000000000000000000000.000 10000000000000000000000.000 12500000000000000000000.000 15000000000000000000000.000 20000000000000000000000.000 25000000000000000000000.000 30000000000000000000000.000 40000000000000000000000.000 50000000000000000000000.000 60000000000000000000000.000 80000000000000000000000.000 100000000000000000000000.000 125000000000000000000000.000 150000000000000000000000.000 200000000000000000000000.000 250000000000000000000000.000 300000000000000000000000.000 400000000000000000000000.000 500000000000000000000000.000 600000000000000000000000.000 800000000000000000000000.000 1000000000000000000000000.000 1250000000000000000000000.000 1500000000000000000000000.000 2000000000000000000000000.000 2500000000000000000000000.000 3000000000000000000000000.000 4000000000000000000000000.000 5000000000000000000000000.000 6000000000000000000000000.000 8000000000000000000000000.000 10000000000000000000000000.000 12500000000000000000000000.000 15000000000000000000000000.000 20000000000000000000000000.000 25000000000000000000000000.000 30000000000000000000000000.000 40000000000000000000000000.000 50000000000000000000000000.000 60000000000000000000000000.000 80000000000000000000000000.000 100000000000000000000000000.000 125000000000000000000000000.000 150000000000000000000000000.000 200000000000000000000000000.000 250000000000000000000000000.000 300000000000000000000000000.000 400000000000000000000000000.000 500000000000000000000000000.000 600000000000000000000000000.000 800000000000000000000000000.000 1000000000000000000000000000.000 1250000000000000000000000000.000 1500000000000000000000000000.000 2000000000000000000000000000.000 2500000000000000000000000000.000 3000000000000000000000000000.000 4000000000000000000000000000.000 5000000000000000000000000000.000 6000000000000000000000000000.000 8000000000000000000000000000.000 10000000000000000000000000000.000 12500000000000000000000000000.000 15000000000000000000000000000.000 20000000000000000000000000000.000 25000000000000000000000000000.000 30000000000000000000000000000.000 40000000000000000000000000000.000 50000000000000000000000000000.000 60000000000000000000000000000.000 80000000000000000000000000000.000 100000000000000000000000000000.000 125000000000000000000000000000.000 150000000000000000000000000000.000 200000000000000000000000000000.000 250000000000000000000000000000.000 300000000000000000000000000000.000 400000000000000000000000000000.000 500000000000000000000000000000.000 600000000000000000000000000000.000 800000000000000000000000000000.000 1000000000000000000000000000000.000 1250000000000000000000000000000.000 1500000000000000000000000000000.000 2000000000000000000000000000000.000 2500000000000000000000000000000.000 3000000000000000000000000000000.000 4000000000000000000000000000000.000 5000000000000000000000000000000.000 6000000000000000000000000000000.000 8000000000000000000000000000000.000 10000000000000000000000000000000.000 12500000000000000000000000000000.000 15000000000000000000000000000000.000 20000000000000000000000000000000.000 25000000000000000000000000000000.000 30000000000000000000000000000000.000 40000000000000000000000000000000.000 50000000000000000000000000000000.000 60000000000000000000000000000000.000 80000000000000000000000000000000.000 100000000000000000000000000000000.000 125000000000000000000000000000000.000 150000000000000000000000000000000.000 200000000000000000000000000000000.000 250000000000000000000000000000000.000 300000000000000000000000000000000.000 400000000000000000000000000000000.000 500000000000000000000000000000000.000 600000000000000000000000000000000.000 800000000000000000000000000000000.000 1000000000000000000000000000000000.000 1250000000000000000000000000000000.000 1500000000000000000000000000000000.000 2000000000000000000000000000000000.000 2500000000000000000000000000000000.000 3000000000000000000000000000000000.000 4000000000000000000000000000000000.000 5000000000000000000000000000000000.000 6000000000000000000000000000000000.000 8000000000000000000000000000000000.000 10000000000000000000000000000000000.000 12500000000000000000000000000000000.000 15000000000000000000000000000000000.000 20000000000000000000000000000000000.000 25000000000000000000000000000000000.000 30000000000000000000000000000000000.000 40000000000000000000000000000000000.000 50000000000000000000000000000000000.000 60000000000000000000000000000000000.000 80000000000000000000000000000000000.000 100000000000000000000000000000000000.000 125000000000000000000000000000000000.000 150000000000000000000000000000000000.000 200000000000000000000000000000000000.000 250000000000000000000000000000000000.000 300000000000000000000000000000000000.000 400000000000000000000000000000000000.000 500000000000000000000000000000000000.000 600000000000000000000000000000000000.000 800000000000000000000000000000000000.000 1000000000000000000000000000000000000.000 1250000000000000000000000000000000000.000 1500000000000000000000000000000000000.000 2000000000000000000000000000000000000.000 2500000000000000000000000000000000000.000 3000000000000000000000000000000000000.000 4000000000000000000000000000000000000.000 5000000000000000000000000000000000000.000 6000000000000000000000000000000000000.000 8000000000000000000000000000000000000.000 10000000000000000000000000000000000000.000 12500000000000000000000000000000000000.000 15000000000000000000000000000000000000.000 20000000000000000000000000000000000000.000 25000000000000000000000000000000000000.000 30000000000000000000000000000000000000.000 40000000000000000000000000000000000000.000 50000000000000000000000000000000000000.000 60000000000000000000000000000000000000.000 80000000000000000000000000000000000000.00	
---	--

# Hammonds Model 6T-2M Injection System Manual

## HAMMONDS SUCTION CALIBRATION GAUGE

### CALIBRATION INSTRUCTIONS

- 1) IN ORDER TO CALIBRATE, THE PUMP MUST BE PRIMED AND PURGED OF ALL AIR. THE 3-WAY VALVE MUST BE SET TO INJECT.
- 2) WITH SUPPLY VALVE OPEN, SLOWLY OPEN VENT VALVE. THIS WILL FILL CALIBRATION GAUGE. DO NOT OVERFILL. ONCE FULL, CLOSE VENT VALVE.
- 3) MAKE NOTE OF ADDITIVE LEVEL IN CALIBRATION GAUGE AND MAIN PRODUCT METER READING. BEGIN CALIBRATION BY FIRST CLOSING THE SUPPLY VALVE AND THEN OPENING THE VENT VALVE. START THE PRODUCT FLOW (SET FOR A SHORT TRIAL RUN).
- 4) AT THE END OF THE RUN, RECORD THE AMOUNT OF ADDITIVE THAT WAS DRAWN FROM THE CALIBRATION GAUGE. RECORD THE AMOUNT OF FUEL PUMPED. CLOSE THE VENT VALVE. OPEN THE SUPPLY VALVE.
- 5) DIVIDE THE AMOUNT OF ADDITIVE USED BY THE VOLUME OF FUEL THAT WAS PUMPED GIVING YOU PPM.
- 6) INCREASE OR DECREASE PERCENTAGE OF STROKE ON DIAPHRAGM PUMP TO OBTAIN DESIRED INJECTION RATIO.

EXAMPLE: (METRIC)  
 ADDITIVE INJECTED = 500 ML  
 FUEL DELIVERED = 1785 LITERS

$$\frac{500}{1785} = .280$$

$$\frac{.280}{1000} = .000280 \text{ (280 MILLIONTHS)}$$

OR 280 PPM (PARTS PER MILLION)

EXAMPLE: (US)  
 ADDITIVE INJECTED = 11.5 oz  
 FUEL DELIVERED = 350 GALLONS

$$\frac{11.5}{350} = .0328$$

$$\frac{.0328}{128 \text{ oz/gal}} = .000256 \text{ (256 MILLIONTHS)}$$

OR 256 PPM (PARTS PER MILLION)

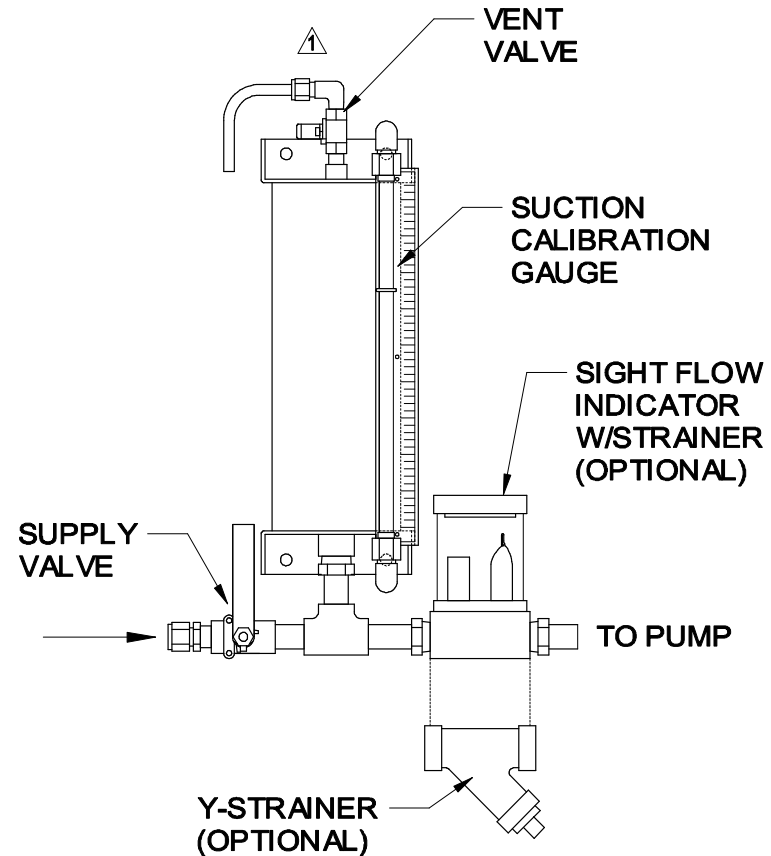

<table border="1" style="width: 100%; border-collapse: collapse;"> <tr> <th>DRAWING</th> <th>LEVELS</th> <th>VIEW</th> </tr> <tr> <td>1891</td> <td>8,9</td> <td>1</td> </tr> </table>					DRAWING	LEVELS	VIEW	1891	8,9	1	*TOLERANCES* ALL DIMENSIONS ARE IN INCHES UNLESS OTHERWISE SPECIFIED.		THIS PRINT IS CONFIDENTIAL AND IS THE PROPERTY OF HAMMONDS TECHNICAL SERVICES		HAMMONDS TECHNICAL SERVICES, INC.																				
					DRAWING	LEVELS	VIEW																												
1891	8,9	1																																	
<table border="1" style="width: 100%; border-collapse: collapse;"> <tr> <td>NO.</td> <td>REVISION</td> <td>DATE</td> <td>BY</td> <td>APPVD</td> </tr> <tr> <td></td> <td></td> <td></td> <td></td> <td></td> </tr> </table>		NO.	REVISION	DATE	BY	APPVD						<table border="1" style="width: 100%; border-collapse: collapse;"> <tr> <td>FROM SER#</td> <td>DATE</td> <td>TO SER#</td> <td>DATE</td> </tr> <tr> <td>X</td> <td>X</td> <td>X</td> <td>X</td> </tr> </table>		FROM SER#	DATE	TO SER#	DATE	X	X	X	X	<table border="1" style="width: 100%; border-collapse: collapse;"> <tr> <td>SCALE</td> <td>NPS</td> <td>APPROVED PART NUMBER</td> <td>DRAWN BY</td> <td>SS</td> </tr> <tr> <td>DATE</td> <td>12/20/07</td> <td>.</td> <td>REVISED</td> <td>03/21/14</td> </tr> </table>		SCALE	NPS	APPROVED PART NUMBER	DRAWN BY	SS	DATE	12/20/07	.	REVISED	03/21/14	DRAWING TITLE <h3 style="text-align: center;">SUCTION CALIBRATION GAUGE</h3>	
NO.	REVISION	DATE	BY	APPVD																															
FROM SER#	DATE	TO SER#	DATE																																
X	X	X	X																																
SCALE	NPS	APPROVED PART NUMBER	DRAWN BY	SS																															
DATE	12/20/07	.	REVISED	03/21/14																															
					SURFACE FINISH: 125/✓ *REMOVE BURRS AND BREAK EDGES .005 MIN.		*CONCENTRICITY: .005 T.I.R. THIS PRINT SHALL NOT BE USED, COPIED OR REPRODUCED IN WHOLE OR IN PART, NOR SHALL THE CONTENTS BE REVEALED IN ANY MANNER TO ANYONE UNLESS WRITTEN PERMISSION IS OBTAINED FROM HAMMONDS TECHNICAL SERVICES.		DRAWING NUMBER <h2 style="text-align: center;">SCG412SS &amp; SCG612SS</h2>																										
							DRAWING NUMBER <h2 style="text-align: center;">1891A</h2>																												